



ಕರ್ನಾಟಕ ಸರ್ಕಾರ

GOVERNMENT OF KARNATAKA

ಕಾಲೇಜು ಮತ್ತು ತಾಂತ್ರಿಕ ಶಿಕ್ಷಣ ಇಲಾಖೆ

DEPARTMENT OF COLLEGIATE AND TECHNICAL EDUCATION

C-20  
2020-21

# Diploma in Computer Science & Engineering



**With Effect from 2020-21**

**C-20**

**Curriculum Development  
Cell**

**Department of Collegiate &  
Technical Education**



## Vision

[(To be drafted individually at institution level)]

To build a strong learning environment in the field of Computer Science and Engineering that responds to the challenges of the century

## Mission

(To be drafted individually at institution level)

-  **M1:** To produce computer science diploma graduates who are trained in design, implementation, testing and maintenance of computational systems through competitive curriculum in collaboration with industry and other organizations.
-  **M2:** Providing state of art facilities for enhancing skills in the field of computer science and engineering.
-  **M3:** To encourage ethical values and leadership abilities in the minds of students so as to work towards the growth of the society.

## Programme Educational Objectives (PEOs)

(To be drafted individually at institution level)

(After 2/3 years of graduation, the students will have the ability to)

1. Attainment of key principles and practices of computation and basic principles of engineering to ensure that technicians are able to apply their software development skills to implement practical systems consisting of software and/or hardware components.
2. Get hands on domain knowledge to pursue higher education.
3. Become socially responsible technicians with good leadership qualities, ethical values and effective interpersonal skills.

## PROGRAM OUTCOMES (POs)

1. **Basic and Discipline specific knowledge:** Apply knowledge of basic mathematics, science and engineering fundamentals and engineering specialization to solve the engineering problems.
2. **Problem analysis:** Identify and analyze well-defined engineering problems using codified standard methods.
3. **Design/ development of solutions:** Design solutions for well-defined technical problems and assist with the design of systems components or processes to meet specified needs.
4. **Engineering Tools, Experimentation and Testing:** Apply modern engineering tools and appropriate technique to conduct standard tests and measurements.
5. **Engineering practices for society, sustainability and environment:** Apply appropriate technology in context of society, sustainability, environment and ethical practices.
6. **Project Management:** Use engineering management principles individually, as a team member or a leader to manage projects and effectively communicate about well-defined engineering activities.
7. **Life-long learning:** Ability to analyze individual needs and engage in updating in the context of technological changes.

**CONSISTENCY MATRIX OF PEO'S WITH MISSION**

	<b>PEO statements</b>	<b>Adapt to Industry</b>	<b>Higher Learning</b>	<b>Team Spirit</b>	<b>Self-Learning</b>	<b>Leadership Qualities</b>	<b>Societal Needs</b>	<b>Environmental Concern</b>
1	Attainment of key principles and practices of computation and basic principles of engineering to ensure that technicians are able to apply their software development skills to implement practical systems consisting of software and/or hardware components.	X		X	X		X	X
2	Get hands on domain knowledge to pursue higher education.		X					
3	Become socially responsible technicians with good leadership qualities, ethical values and effective interpersonal skills.	X				X	X	

**PROGRAM SPECIFIC OUTCOMES (PSOs)**

**Program shall specify 2-4 Program Specific Outcomes  
(To be drafted individually at institution level)**

1. Demonstrate skills in the core knowledge areas of Data Structures, Programming Languages, Databases, Software Engineering, Development & testing, Computer Hardware and Networking.
2. Apply problem-solving skills and the knowledge of computer science to solve real world problems.
3. Develop technical project and present the reports effectively

**1.0 GENERAL PROGRAMME STRUCTURE AND CREDIT DISTRIBUTION**

1. **Definition of Credit:** Credit is a kind of weightage given to the contact hours to teach the prescribed syllabus, which is in a modular form. For courses, one credit is allocated to one contact hour for theory / tutorial per week and one credit is allocated to 02 contact hours for practical.
2. **Choice-Based Credit System (CBCS):** CBCS is a flexible system of learning that permits students to learn at their own pace, choose electives from a wide range of elective courses and adopt an inter-disciplinary approach in learning and make best use of the expertise of available faculty.

### 3. Range of Credits

1 Hr. Lecture (L) per week	1 credit
1 Hr. Practical (P) per week	0.5 credit
1 Hr. Tutorial (T) per week	1 credit
4 Hrs. Theory (T) per week	4 credit
3 Hrs. Practical (P) per week [1 Hr. Tutorial +2 Hrs. Practical]	2 credit

4. **Programme:** Programme means Diploma Programme that is Diploma in Computer Science & Engineering, which is of three years duration.

### 2.0 PROGRAMME STRUCTURE

- Course:** A Course is a component (a paper) of a Programme. All the courses need not carry same weightage. The course should define Course objectives. A course may be designed to involve lectures / tutorials / laboratory work / seminar / project work/ Internships / seminar or a combination of these, to meet effectively the teaching and learning needs and the credits may be assigned suitably.
- Course Code:** Each course shall have an alphanumeric code, which includes last two digits of year of introduction such as 20 subject code CS (CS for Computer Science & engineering, CH for Chemical Engineering etc.), then first two digits for example 12 (where 1 represents first semester and 2 represents the course number in incremental order) and the last alphabet represent Theory (T), Practical/Internship/Project (P), Drawing (D), Programme / Open Electives (A, B, C, E, F, G ...).
- Programme Courses:** Each Programme will consist of Communication skills and Social Sciences (HS), Engineering Mathematics, Statistics and Analytics (BS), Engineering Sciences (ES), Professional Core (PC), Professional Electives (PE), Open Electives (OE), Employability Enhancement Courses (EEC) and Internships.
  - Communication Skills and Social Sciences:** Communication Skills and Social Science courses are incorporated in the curriculum to meet the desired needs of communication and life skills amongst students.
  - Engineering Mathematics, Statistics and Analytics:** Common to all Engineering Programme to develop reasoning and analytical skills amongst students.
  - Engineering Sciences:** Engineering Science shall create awareness on different specializations of engineering studies. The goal of these courses is to create engineers of tomorrow, who possess the knowledge of all disciplines and can apply their interdisciplinary

knowledge in every aspect. It could be any branch of engineering - Civil, Computer Science and Engineering, Electrical, Mechanical, etc.

4. **Professional Core:** Core Courses designed in the programme which are major courses of the discipline, required to attain desired outcomes and to ignite critical thinking skills amongst students.
5. **Professional Elective:** Generally, a course can be chosen from a pool of courses and which may be very specific or specialized or advanced or supportive to the discipline or nurtures the candidate's proficiency/skill is called Professional Elective Course.
6. **Open Electives:** An elective course chosen generally from other discipline/ subject, with an intention to seek interdisciplinary exposure is called an open elective. While choosing the electives, students shall ensure that they do not opt for the courses with syllabus contents of which are similar to that of their departmental core/elective courses.
7. **Audit / Non-Core Courses:** An audit / Non-core course is one in which the student attends classes, does the necessary assignments, and takes exams. The Institute encourages students towards extra learning by auditing for additional number of courses. The results of audit courses shall not be considered for prescribed "carry over courses" limit, however students need to pass audit courses for awarding the diploma.
8. **Employability Enhancement Courses:** It contains the following courses:
  - a. **Mini Project:** Mini Project is a laboratory-oriented course which will provide a platform to students to enhance their practical knowledge and skills by development of small systems/application.
  - b. **Seminar:** Seminar should be based on thrust areas in state of art technologies. Students should identify the topic of seminar and finalize in consultation with Guide. Students should understand the topic and compile the report in standard format and present in front of Panel of Examiners respective Programme.
  - c. **Major Project:** Every student must do one major project in the Final year of their program. The minimum duration of project is 6 months. Students can do their major project in Industry or R&D Lab or in house or combination of any two.

**3.0 COURSE CODE AND DEFINITION:**

Course code	Definitions	Teaching Dept. Code	Name of the Teaching Department	Teaching Dept. Code	Name of the Teaching Department
L	Lecture	SC	Science	MI	Mechanical Engineering [Instruments]
T	Tutorial	CP	Commercial Practice / English	CR	Ceramic Engineering
P	Practical	ME	Mechanical Engineering	EN	Civil Environmental Engineering
HS	Humanities & Social Sciences Courses	EE	Electrical & Electronics Engg.	AN	Aeronautical Engg.
BS	Basic Science Courses	CE	Civil Engineering	MN	Mining & Mine Surveying
ES	Engineering Science Courses	EC	Electronics & Commn. Engineering	MM	Modern Office Management
PC	Program Core Courses	CS	Comp Science & Engg.	LI	Library and Information Science
PE	Program Elective Courses	IS	Info Science & Engg.	FT	Apparel Design and Fabrication Technology
OE	Open Elective Courses	AT	Automobile Engg.	CH	Chemical Engineering
AU	Audit Courses	MC	Mechatronics	PO	Polymer Technology
SI	Summer Internship	MT	Metallurgical Engg.	PT	Printing Technology
PR	Project	HP	Mechanical Engineering [HPT]	TX	Textile Technology
SE	Seminar	WS	Mechanical Engineering [Welding & Sheet Metal]	EI	Electronic Instrumentation & Control Engineering
CIE	Continuous Internal Evaluation	CN	Cinematography	LT	Leather & Fashion Technology
SEE	Semester End Examination	SR	Sound Recording & Engineering	WH	Water Technology & Health Science
		PH	Civil (Public Health & Environment) Engg.	MY	Mechanical Engineering [Machine Tools]
		TD	Tool & Die Making	AR	Architecture
		ID	Interior Decoration	EG	English

**4.0 INDUCTION PROGRAMME**

The Essence and Details of Induction program can also be understood from the “Detailed Guide on Student Induction program”, as available on AICTE Portal, although that is for Diploma students of Engineering & Technology. Suggestive schedule for induction program is given below

[\[Link:https://www.aicteindia.org/sites/default/files/Detailed%20Guide%20on%20Student%20Induction%20program.pdf\]](https://www.aicteindia.org/sites/default/files/Detailed%20Guide%20on%20Student%20Induction%20program.pdf)

### Induction Program Schedule (Suggestive only)

*(Induction program for students to be offered right at the start of the first year)*

SL NO	DAY	TIME	ACTIVITY	VENUE
1	1	09.30-12.30	Registration, Formation of Mentor-mentee groups – Introduction of mentors with-in group.	Classrooms of respective programs
		01.30-04.30	Screening of Institute video clips of various functions held and Photos of various events, Institution Excursion	Seminar hall
2	2	09.30-12.30	Prayer- Physical activities such as yoga; Presentation cum Interactive Session with: Important Institution Functionaries like Principal, HoD's etc.	Playground and seminar hall
		01.30-04.30	Visit to Central facilities such as Reading room,library,Sport center, computer center, hostel, NSS/NCC cell, community development cell functioning in polytechnic	Tour
		01.30-04.30	Lecturer sessions about importance of NSS/NCC/Youth red cross activities and their contribution towards national building and personality and character development	Seminar hall
4	4	09.30-12.30	Personality development talk on Human values	Seminar hall
		01.30-04.30	Interaction with Alumni students of polytechnic of different programs and interaction with few alumina and sharing their experiences	Seminar hall
5	5	09.30-12.30	Introduction to Swatch Bharath Abhiyan-Importance of Abhiyan-Clean drive in around college	Campus
		01.30-04.30	Talent hunt-Music/Antyakshri/Instrument play/ Dance/Team Activity	College Auditorium
6	6	09.30-12.30	Talent hunt Activity: Essay/Debate/Best out of Waste/Pick and speak, other	Seminar hall
		01.30-04.30	Screening of Movie related: personality development, character building, motivational, Environmental concern, Public health, rural sanitation	College Auditorium
7	7	09.30-12.30	Exchange of views between students and faculty about their Institute/program/carrier opportunities	Seminar hall
		01.30-04.30	Games/Sports Activity	Sports ground
8	8	09.30-12.30	Talk by training and placement cell: Carrier opportunities for diploma students, placement activities in college; placement process	Training and placement cell
		01.30-04.30	Talents hunt Activity: (Street Play/Mime/Acting/Stand Up Comedy /Dance etc.)	Seminar hall
9	9	09.30-12.30	Personality development talks by eminent speakers on -Leadership styles/How to handle failures/stress management	Seminar hall
		01.30-04.30	Importance of student union, student union activities, Student insurance, How to make student insurance by Student welfare officer of college	Seminar hall
10	10	09.30-12.30	Awareness on; Student scholarship- introduction to SSP portal –e-pass portal-Authenticated documents, how to apply in portal: Talk by Taluk/District social welfare officer	Seminar hall

		01.30-04.30	Local visits to surrounding places/Industry	Tour
11	11	09.30-12.30	<b>Talk on</b> Respective Program scheme of studies and detail of courses, Diploma examination pattern, Passing and eligibility criteria, attendance requirements by respective program coordinator	Department Classrooms
		01.30-04.30	Visit to respective programs lab/workshops of institution	Tour
12	12	09.30-12.30	Awareness camp on human health, Community health, Personal hygiene-By Local Taluk medical officer/Community medical officer	Seminar hall
		01.30-04.30	Collection of student feedback on induction program- Make a report Valedictory of two weeks Induction program by collecting student feedback	Seminar hall

Induction Program (mandatory)	Two- week Duration
Induction program for students to be offered right at the start of the first year.	<ul style="list-style-type: none"> <li>• Physical activity</li> <li>• Creative arts</li> <li>• Universal human values</li> <li>• Literacy</li> <li>• Proficiency modules</li> <li>• Lectures by Eminent People</li> <li>• Visits to Local Areas</li> <li>• Familiarization to Dept./Branch &amp; Innovations</li> </ul>

### 5.0 MANDATORY VISITS/WORKSHOP/EXPERT LECTURES:

1. It is mandatory to arrange one industrial visit every semester for the students of each branch.
2. It is mandatory to conduct a One-week workshop during the winter break after fifth semester on professional/ industry/ entrepreneurial orientation.
3. It is mandatory to organize at least one expert lecture per semester for each branch by inviting resource persons from domain specific industry.

### 6.0 EVALUATION SCHEME:

#### **A. For Theory Courses:**

The weightage of Continuous Internal Evaluation (CIE) is 50% and for Semester End Exam (SEE) is 50%. The student has to obtain minimum of 40% marks individually both in CIE and SEE to pass. Theory Semester End Exam (SEE) is conducted for 100 marks (3 Hours duration). Based on this grading will be awarded

#### **B. For Practical Courses:**

The weightage of Continuous Internal Evaluation (CIE) is 60% and for Semester End Exam (SEE) is 40%. The student has to obtain minimum of 40% marks individually both CIE and SEE to pass. The practical Semester End Exam (SEE) is conducted for 100 marks (3 Hours duration exams). Based on this grading will be awarded.



**C. For Summer Internship / Projects / Seminar etc.**

1. Evaluation is based on work done, quality of report, performance in viva-voce, presentation etc.

**Note:**

- A. The Continuous Internal Evaluation (CIE) is based on the student's performance in Internal Assessment tests, student activity, mini project, quizzes, assignments, seminars, viva-voce in practical, lab record etc. as specified in respective course curriculum.
- B. **Major Project/Mini Project:** Students can do their major project in Industry or R&D Labor in house. Mini Project is a laboratory-oriented course which will provide a platform to students to enhance their practical knowledge and skills by development of small systems/application.
- C. **Personality and character development:** It is mandatory for the students from 1<sup>st</sup> semester to enroll in any one of the personality and character development programmes (NCC/NSS/YRC/Yoga/Technical Club) and undergo training for their Personality and character development.
  - National Cadet Corps (NCC).
  - National Service Scheme (NSS) will have social service activities in and around the Institution.
  - Youth Red Cross (YRC) will have activities in and around the institution.
  - Yoga
  - Technical Clubs.
- D. **Internship:** A minimum of 10 credits (400 Hours) of Internship/ Entrepreneurial activities / Project work/ Seminar and Inter/ Intra Institutional Training may be counted toward three-year diploma programme.
- E. **Mapping of Marks to Grades:** Each course (Theory/Practical) is to be assigned 100 marks, irrespective of the number of credits, and the mapping of marks to grades may be done as per the following table:

Range of Marks	Level	Assigned Grade	Grade Point
91-100	Outstanding	A+	10
81-90	Excellent	A	09
71-80	Very Good	B+	08
61-70	Good	B	07
51-60	Above Average	C+	06
45-50	Average	C	05
40-44	Satisfactory	D	04
<40	Fail	F	00

Fail due to shortage of attendance and therefore, to repeat the course/semester.	F*	00
Fail in Continuous internal Evaluation (CIE).	F**	00
<p>Note: Those Candidates who have not obtained requisite minimum pass marks in CIE are not eligible to take up SEE in that course until they get requisite minimum pass marks in the CIE. They may re- register for the CIE in the subsequent regular semesters by paying prescribed examination fee.</p>		
<b>SGPA and CGPA Calculations</b>		
<b>Semester Grade Point Average (SGPA)=</b>	$\sum[(\text{Course Credits earned}) \times (\text{Grade Points})]$ for all the courses in that semester	
	$\sum[\text{Total Course credits applied}]$ for all the courses in that semester	
<b>Cumulative Grade Point Average(CGPA)=</b>	$\sum[(\text{Course Credits earned}) \times (\text{Grade Points})]$ for all courses, excluding those with F*/F** grades until that semester	
	$\sum[\text{Total Course Credits earned}]$ for all Courses excluding those with F*/F** grades until that semester	
<p>Note: The SGPA and CGPA shall be rounded off to 2 decimal points and reported in the semester Diploma marks /grade card.</p>		

**A. SGPA and CGPA Calculations: An illustrative example for one academic year**

Semester	Course Code	Credits Applied (CA)	Result Grade	Grade Points (GP)	Credits Earned (CE)	Credit points (CP=CE x GP)	SGPA, CGPA
I	Course 1	4	B	7	4	4x7=28	SGPA=CP/CA =110/22 = 5.00
I	Course 2	4	F	0	0	0x0=00	
I	Course 3	4	Absent (F)	0	0	0x0=00	
I	Course 4	4	A	9	4	4x9=36	
I	Course 5	2	A+	10	2	2x10=20	
I	Course 6	2	D	4	2	2x4=08	
I	Course 7	2	A	9	2	2x9=18	
	Total	22			14	110	<b>SGPA = 5.00</b>

Note: In 1<sup>st</sup> semester grade/marks card only SGPA is reported. From 2<sup>nd</sup> semester onwards both SGPA & CGPA will be reported in the grade/marks card.

Semester	Course Code	Credits Applied (CA)	Result Grade	Grade Points (GP)	Credits Earned (CE)	Credit points (CP=C x GP)	SGPA, CGPA
II	Course 1	4	B	7	4	4x7=28	SGPA=CP/CA =100/19 = 5.26
II	Course 2	4	A	9	4	4x9=36	
II	Course 3	3	D	4	3	3x4=12	
II	Course 4	3	Absent (F)	0	0	0x0=00	
II	Course 5	2	A+	10	2	2x10=20	CGPA = CP/CE =(110+136)/ (14+22) = 246/36
II	Course 6	1	D	4	1	1x4=04	
II	Course 7	2	F	0	0	0x0=00	
		19			14	100	
I Semester Back log courses							

I	Course 2	4	C	5	4	4x5=20	=6.83
I	Course 3	4	D	4	4	4x4=16	
	Total	27			22	136	

- Total credits of the semester excluding the credits of the courses under F/F\*/F\*\* grade are considered for the calculation of CGPA of the two consecutive semesters under consideration.

**B. CGPA Calculation of the entire programme: An Illustrative Example.**

Semester	I	II	III	IV	V	VI	Total
Credits of the Semester	22	19	24	24	24	24	137
$\sum CP$	110	136	184	155	191	188	964

$$CGPA = \frac{[110+136+184+155+191+18]}{22+19+22+24+24+24} = \frac{964}{137} = 7.04$$

**P=Percentage Conversion= (CGPA-0.75) X 10**  
**Class Declaration:**

After the conversion of final CGPA into percentage of marks (P), a graduating student is declared to have passed in:

- (i) First Class with Distinction (FCD) if  $P \geq 70\%$
- (ii) First Class (FC) if  $P \geq 60\%$  but  $<70\%$  and
- (iii) Second Class (SC) if  $P < 60\%$ .

**SCHEME OF STUDIES  
DIPLOMA IN COMPUTER SCIENCE  
& ENGINEERING  
(C-20)**

**CURRICULUM STRUCTURE**

***I Semester Scheme of Studies - Diploma in Computer Science & Engineering [C-20]***

S. N	Course Category / Teaching Department	Course Code	Course Title	Hours per week			Total contact hrs /week	Credits	CIE Marks		SEE Marks		Total Marks	Min Marks for Passing (including CIE)	Assigned Grade	Grade Point	SGPA and CGPA
				L	T	P			Max	Min	Max	Min					
<b>THEORY COURSES</b>																	
1	BS/SC	20SC01T	Engineering Mathematics	4	0	0	4	4	50	20	50	20	100	40			<b>Only SGPA for 1<sup>st</sup> Semester</b>
2	ES/CS	20CS11T	Fundamentals of Computer	4	0	0	4	4	50	20	50	20	100	40			
<b>PRACTICAL COURSES</b>																	
3	ES/EE/EC	20EC01P	Fundamentals of Electrical & Electronics Engineering	2	0	4	6	4	60	24	40	16	100	40			
4	ES/CS	20CS01P	IT Skills	2	0	4	6	4	60	24	40	16	100	40			
<b>AUDIT COURSES</b>																	
5	AU/SC	20AU01T	Environment Sustainability	2	0	0	2	2	50	20	-	-	50	20			
6	AU Physical Activity		Sports/NCC/NSS/Youth Red Cross/Yoga/ Technical club.	Student shall enrol in any one of these activities in 1 <sup>st</sup> semester and shall participate actively. The student shall obtain 'Participation Certificate' in the activity to get eligible for the award of Diploma.													
<b>Total</b>				<b>14</b>	<b>0</b>	<b>8</b>	<b>22</b>	<b>18</b>	<b>270</b>	<b>108</b>	<b>180</b>	<b>72</b>	<b>450</b>	<b>180</b>			

T:- Theory P:- Practical D:- Drawing E:- Elective BS- Basic Science:: ES-Engineering Science:: HS-Humanities & Social Science:: AU-Audit Course:: EG: English ::SC: Science

**Note:**

- Assigned Grade, Grade Point, SGPA and CGPA to be recorded in the Grade/Marks card.
- AU- Physical Activity- Student participation in the selected physical activity shall be monitored and the participation record shall be maintained by the respective Programme Coordinator (Head of Section).
- Theory course Semester End Examination (SEE) is conducted for 100 marks (3 Hours duration)
- Practical course CIE and SEE is conducted for 100 marks (3 Hours duration)

**II Semester Scheme of Studies - Diploma in Computer Science & Engineering [C-20]**

Sl. No	Course Category / Teaching Department	Course Code	Course Title	Hours per week			Total contact hrs/week	Credits	CIE Marks		SEE Marks		Total Marks	Min Marks for Passing (including CIE marks)	Assigned Grade	Grade Point	SGPA and CGPA
				L	T	P			Max	Min	Max	Min					
<b>THEORY COURSES</b>																	<b>S</b>
1	SC/CS	20PM01T	Project Management Skills	2	0	4	6	4	50	20	50	20	100	40			
<b>PRACTICAL COURSES</b>																	
2	BS/SC	20SC02P	Statistics and Analytics	2	0	4	6	4	60	24	40	16	100	40			
3	EG/SC /CS	20EG01P	Communication Skills	2	0	4	6	4	60	24	40	16	100	40			
4	ES/ME	20ME02P	Computer Aided Engineering Graphics	2	0	4	6	4	60	24	40	16	100	40			
5	ES/CS	20CS21P	Multimedia & Animation	2	0	4	6	4	60	24	40	16	100	40			
<b>AUDIT COURSES</b>																	
6	AU/KA	20KA21T	Kannada-I/ಸಾಹಿತ್ಯಸಿಂಚನ I /ಬಳಕೆ ಕನ್ನಡ - I	2	0	0	2	2	50	20	-	-	50	20			
<b>Total</b>				<b>12</b>	<b>0</b>	<b>20</b>	<b>32</b>	<b>22</b>	<b>340</b>	<b>136</b>	<b>210</b>	<b>84</b>	<b>550</b>	<b>220</b>			

T:- Theory P:- Practical D:- Drawing E:- Elective BS- Basic Science:: ES-Engineering Science:: HS-Humanities & Social Science:: AU-Audit Course:: EG: English ::SC: Science

**Note:**

1. Assigned Grade, Grade Point, SGPA and CGPA to be recorded in the Grade/Marks card.
2. Theory course Semester End Examination (SEE) is conducted for 100 marks (3 Hours duration)
3. Practical course CIE and SEE is conducted for 100 marks (3 Hours duration)

**Government of Karnataka**  
**Department of Collegiate and Technical Education**  
**Board of Technical Examinations, Bangalore**

<b>Course Code</b>	20SC01T	<b>Semester</b>	I/II
<b>Course Title</b>	<b>ENGINEERING MATHEMATICS</b>	<b>Course Group</b>	Core
<b>No. of Credits</b>	4	<b>Type of Course</b>	Lecture
<b>Course Category</b>	Theory	<b>Total Contact Hours</b>	4Hrs Per Week
			52Hrs Per Semester
<b>Prerequisites</b>	10 Level Mathematics	<b>Teaching Scheme</b>	(L:T:P) = 4:0:0
<b>CIE Marks</b>	50	<b>SEE Marks</b>	50

### RATIONALE

Engineering Mathematics specification provides students with access to important mathematical ideas to develop the mathematical knowledge and skills that they will draw on in their personal and work lives. The course enable students to develop mathematical conceptualization, inquiry, reasoning, and communication skills and the ability to use mathematics to formulate and solve problems in everyday life, as well as in mathematical contexts. At this level, the mathematics curriculum further integrates the three content areas taught in the higher grades into three main learning areas: Algebra; Measurement of angles and Trigonometry and Calculus.

### 1. COURSE SKILL SET

*Student will be able to:*

1. Solve system of linear equations arise in different engineering fields
2. Incorporate the knowledge of calculus to support their concurrent and subsequent engineering studies
3. Adept at solving quantitative problems
4. Ability to understand both concrete and abstract problems
5. Proficient in communicating mathematical ideas
6. Detail-oriented

### 2. COURSE OUT COMES

*At the end of the course, student will be able to*

<b>CO1</b>	Determine the inverse of a square matrix using matrix algebra. Apply the concepts of matrices and determinants to solve system of linear equations and find eigen values associated with the square matrix.
<b>CO2</b>	Find the equation of straight line in different forms. Determine the parallelism and perpendicularity of lines.
<b>CO3</b>	Calculate trigonometric ratios of allied angles and compound angles. Transform sum or difference of trigonometric ratios into product and vice versa.

<b>CO4</b>	Differentiate various continuous functions and apply the concept in real life situations.
<b>CO5</b>	Integrate various continuous functions and apply the concept in evaluating the area and volume through definite integrals.

### 3. SUGGESTED SPECIFICATION TABLE WITH HOURS & MARKS

UNIT NO	UNIT TITLE	TEACHING HOURS	DISTRIBUTION(THEORY)			
			R LEVEL	U LEVEL	A LEVEL	TOTAL
1	Matrices and Determinants	10	8	20	12	40
2	Straight lines	10	8	20	12	40
3	Trigonometry	10	8	20	12	40
4	Differential Calculus and applications	11	8	20	12	40
5	Integral Calculus and applications	11	8	20	12	40
	<b>Total</b>	<b>52</b>	<b>40</b>	<b>100</b>	<b>60</b>	<b>200</b>

**Legends:** R = Remember; U = Understand; A = Apply and above levels (Bloom's revised taxonomy)

### 4. DETAILS OF COURSE CONTENT

The following topics/subtopics is to be taught and assessed in order to develop Unit Skill sets for achieving CO to attain identified skill sets.

UNIT NO	Unit skill set (In cognitive domain)	Topics/Subtopics	Hours L-T-P
<b>UNIT-1 MATRICES AND DETERMINANTS</b>	<ul style="list-style-type: none"> <li>➤ Use algebraic skills which are essential for the study of systems of linear equations, matrix algebra and eigen values</li> </ul>	1.1 Matrix and types 1.2 Algebra of Matrices (addition, subtraction, scalar multiplication and multiplication) 1.3 Evaluation of determinants of a square matrix of order 2 and 3. Singular matrices 1.4 Cramer's rule for solving system of linear equations involving 2 and 3 variables 1.5 Adjoint and Inverse of the non-singular matrices of order 2 and 3 1.6 Characteristic equation and Eigen values of a square matrix of order 2	10-0-0



<b>UNIT-2 STRAIGHT LINES</b>	<ul style="list-style-type: none"> <li>➤ Able to find the equation of a straight line in different forms</li> <li>➤ Determine whether the lines are parallel or perpendicular</li> </ul>	2.1 Slope of a straight line 2.2 Intercepts of a straight line 2.3 Intercept form of a straight line 2.4 Slope-intercept form of a straight line 2.5 Slope-point form of a straight line 2.6 Two-point form of a straight line 2.7 General form of a straight line 2.8 Angle between two lines and conditions for lines to be parallel and perpendicular 2.9 Equation of a straight line parallel to the given line 2.10 Equation of a straight line perpendicular to the given line	10-0-0
<b>UNIT-3 TRIGONOMETRY</b>	<ul style="list-style-type: none"> <li>➤ Use basic trigonometric skills in finding the trigonometric ratios of allied and compound angles</li> <li>➤ Able to find all the measurable dimensions of a triangle</li> </ul>	3.1 Concept of angles, their measurement, Radian measure and related conversions. 3.2 Signs of trigonometric ratios in different quadrants (ASTC rule) 3.3 Trigonometric ratios of allied angles (definition and the table of trigonometric ratios of standard allied angles say $90^\circ \pm \theta$ , $180^\circ \pm \theta$ , $270^\circ \pm \theta$ and $360^\circ \pm \theta$ ) 3.4 Trigonometric ratios of compound angles (without proof) 3.5 Trigonometric ratios of multiple angles 3.6 Transformation formulae	10-0-0
<b>UNIT-4 DIFFERENTIAL CALCULUS AND APPLICATIONS</b>	<ul style="list-style-type: none"> <li>➤ Able to differentiate algebraic, exponential, trigonometric, logarithmic and composite functions</li> <li>➤ Able to find higher order derivatives</li> <li>➤ Understand and work with derivatives as rates of change in mathematical models</li> <li>➤ Find local maxima and minima of a function</li> </ul>	4.1 Derivatives of continuous functions in an interval (List of formulae) 4.2 Rules of differentiation 4.3 Successive differentiation (up to second order) 4.4 Applications of differentiation	11-0-0
<b>UNIT-5 INTEGRAL CALCULUS AND APPLICATIONS</b>	<ul style="list-style-type: none"> <li>➤ Understand the basic rules of integration and Evaluate integrals with basic integrands.</li> <li>➤ Identify the methods to evaluate integrands</li> <li>➤ Apply the skills to evaluate integrals representing areas and volumes</li> </ul>	5.1 List of standard integrals and Basic rules of integration 5.2 Evaluation of integrals of simple function and their combination 5.3 Methods of integration 5.4 Concept of definite integrals 5.5 Applications of definite integrals	11-0-0

**5. MAPPING OF CO WITH PO**

CO	Course Outcome	PO Mapped	UNIT Linked	CL R/U/A	Theory in Hrs	TOTAL
<b>C01</b>	Determine the inverse of a square matrix using matrix algebra. Apply the concepts of matrices and determinants to solve system of linear equations and find eigen values associated with the square matrix.	1, 7	1	R/U/A	10	<b>40</b>
<b>C02</b>	Find the equation of straight line in different forms. Determine the parallelism and perpendicularity of lines.	1, 7	2	R/U/A	10	<b>40</b>
<b>C03</b>	Calculate trigonometric ratios of allied angles and compound angles. Transform sum (difference) of trigonometric ratios into product and vice versa.	1, 7	3	R/U/A	10	<b>40</b>
<b>C04</b>	Differentiate various continuous functions and apply the concept in real life situations.	1, 3, 7	4	R/U/A	11	<b>40</b>
<b>C05</b>	Integrate various continuous functions and apply the concept in evaluating the area and volume through definite integrals.	1, 3, 7	5	R/U/A	11	<b>40</b>
					<b>52</b>	<b>200</b>

Course	CO's	Programme Outcomes (PO's)						
		1	2	3	4	5	6	7
ENGINEERING MATHEMATICS	C01	3	1	0	0	0	0	3
	C02	3	1	0	0	0	0	3
	C03	3	1	0	0	0	0	3
	C04	3	1	3	0	0	0	3
	C05	3	1	3	0	0	0	3
<b>Level 3- Highly Mapped, Level 2-Moderately Mapped, Level 1-Low Mapped, Level 0- Not Mapped</b>								

## 7. INSTRUCTIONAL STRATEGY

These are sample Strategies, which teacher can use to accelerate the attainment of the various course outcomes

1. Explicit instruction will be provided in intervention classes or by using different differentiation strategies in the main classroom.
2. Lecturer method (L) does not mean only traditional lecture method, but different type of teaching method and media that are employed to develop the outcomes.
3. Observing the way their more proficient peers use prior knowledge to solve current challenges and persevere in problem solving will help struggling students to improve their approach to engaging with rich contextual problems.
4. Ten minutes a day in homeroom, at the end of class, or as a station in a series of math activities will help students build speed and confidence.
5. Topics will be introduced in a multiple representation.
6. The teacher is able to show different ways to solve the same problem and encourage the students to come up with their own creative ways to solve them.
7. In a perfect world, teacher would always be able to demonstrate how every concept can be applied to the real world - and when that's possible, it helps improve the students' understanding. When a concept cannot be applied in that manner, we can still share how it might be applied within mathematics.

## 8. SUGGESTED LEARNING RESOURCES:

Sl. No.	Author	Title of Books	Publication/Year
1	B.S. Grewal	Higher Engineering Mathematics	Khanna Publishers, New Delhi, 40th Edition, 2007
2	G. B. Thomas, R. L. Finney	Calculus and Analytic Geometry	Addison Wesley, 9th Edition, 1995
3	S.S. Sabharwal, Sunita Jain, Eagle Parkashan	Applied Mathematics, Vol. I & II	Jalandhar.
4	Comprehensive Mathematics	Comprehensive Mathematics Vol. I & II	Laxmi Publications, Delhi
5	Reena Garg & Chandrika Prasad	Advanced Engineering Mathematics	Khanna Publishing House, New Delhi

**9. COURSE ASSESSMENT AND EVALUATION CHART**

Sl.No.	Assessment	Duration	Max marks	Conversion
1	CIE Assessment 1 (Written Test -1) At the end of 3 <sup>rd</sup> week	80 minutes	30	Average of three written tests  30
2	CIE Assessment 2 (Written Test -2) At the end of 7 <sup>th</sup> week	80 minutes	30	
3	CIE Assessment 3 (Written Test -3) At the end of 13 <sup>th</sup> week	80 minutes	30	
4	CIE Assessment 4 (MCQ/Quiz) At the end of 5 <sup>th</sup> week	60 minutes	20	Average of three  20
5	CIE Assessment 5 (Open book Test) At the end of 9 <sup>th</sup> week	60 minutes	20	
6	CIE Assessment 6 (Student activity/Assignment) At the end of 11 <sup>th</sup> week	60 minutes	20	
Total Continuous Internal Evaluation (CIE) Assessment				<b>50</b>
8	Semester End Examination (SEE) Assessment (Written Test)	3 Hours	100	<b>50</b>
<b>Total Marks</b>				<b>100</b>

**Note:**

- SEE (Semester End Examination) is conducted for 100 Marks theory courses for a time duration of 3 Hours.
- Three CIE (written test), each of 30 marks for a time duration of 80 minutes shall be conducted. Also, three CIE (MCQ or Quiz/Open book test/student activity or assignment) each of 20 marks for the time duration of 60 minutes shall be conducted. Any fraction at any stage during evaluation will be rounded off to the next higher digit
- Assessment of assignment and student activity is evaluated through appropriate rubrics by the respective course coordinator. The secured mark in each case is rounded off to the next higher digit.

**10 DETAILED COURSE CONTENT**

UNIT NO AND NAME	DETAILED COURSE CONTENT	CO	PO	CONTACT HRS	TOTAL
<b>1</b> <b>MATRICES AND DETERMINANTS</b>	Definition and types of matrices	1	1,7	1	<b>10</b>
	Algebra of Matrices (addition, subtraction and scalar multiplication) problems	1	1,7	1	
	Multiplication of Matrices(problems)	1	1,7	1	
	Evaluation of 2x2 ,3x3 determinants and Singular matrices and problems in finding unknown variable	1	1,7	1	
	Cramer's rule to solve system of linear equation with 2 and 3 variables	1	1,7	1	
	Cramer's rule to solve system of linear equation with 2 and 3 variables.problems	1	1,7	1	
	Minors, Cofactors of elements of square matrices of order 2 and 3	1	1,7	1	
	Adjoint of a square matrix(2x2 and 3x3),Inverse of a non singular square matrix	1	1,7	1	
	Adjoint of a square matrix(2x2 and 3x3),Inverse of a non singular square matrix and problems	1	1,7	1	
	Characteristic equation and eigen values of a 2x2 matrix and problems	1	1,7	1	
	<b>2</b> <b>STRAIGHTLINES</b>	Slope of the straight line(provided with inclination and two points on the line as well) and problems	2	1,7	
Intercepts of a straight line and problems		2	1,7	1	
Intercept form of a straight line and problems		2	1,7	1	
Slope-intercept form of a straight line and problems		2	1,7	1	
Slope-point form of the straight line and problems		2	1,7	1	
Two-point form of a straight line and problems		2	1,7	1	
General form of a straight line.problems on finding slope and intercepts.		2	1,7	1	
Angle between two straight lines and conditions for the lines to be parallel and perpendicular and problems		2	1,7	1	
Equation of a line pallel to the given line and problems		2	1,7	1	
Equation of a line perpendicular to the given line.problems		2	1,7	1	

<b>3</b> <b>TRIGONOMETRY</b>	Concept of angles and their measurement. Radian measures and related conversions (degree to radian and vice-versa) and problems	<b>3</b>	<b>1,7</b>	<b>1</b>	<b>10</b>
	Signs of trigonometric ratios in different quadrants (ASTC rule)	<b>3</b>	<b>1,7</b>	<b>1</b>	
	Trigonometric ratios of allied angles (definition and the table of trigonometric ratios of standard allied angles say $90^\circ \pm \theta$ , $180^\circ \pm \theta$ , $270^\circ \pm \theta$ and $360^\circ \pm \theta$ )	<b>3</b>	<b>1,7</b>	<b>1</b>	
	Problems on allied angles. (proving identities)	<b>3</b>	<b>1,7</b>	<b>1</b>	
	Problems on allied angles. (Finding values of x in an identity)	<b>3</b>	<b>1,7</b>	<b>1</b>	
	Trigonometric ratios of compound angles (without proof)	<b>3</b>	<b>1,7</b>	<b>1</b>	
	Trigonometric ratios of multiple angles ( $\sin 2A$ , $\cos 2A$ , $\tan 2A$ , $\sin 3A$ , $\cos 3A$ and $\tan 3A$ )	<b>3</b>	<b>1,7</b>	<b>1</b>	
	Problems on multiple angles $\sin 2A$ , $\cos 2A$ , $\tan 2A$ , $\sin 3A$ , $\cos 3A$ and $\tan 3A$	<b>3</b>	<b>1,7</b>	<b>1</b>	
	Transformation formulae (without proof) as sum to product. (Simple problems)	<b>3</b>	<b>1,7</b>	<b>1</b>	
	Transformation formulae (without proof) as product to sum. (Simple problems)	<b>3</b>	<b>1,7</b>	<b>1</b>	
<b>4</b> <b>DIFFERENTIAL CALCULUS AND APPLICATIONS</b>	Definition of a derivative of a function. Listing the derivatives of standard functions. (Algebraic, trigonometric, exponential, logarithmic and inverse trigonometric functions)	<b>4</b>	<b>1,3,7</b>	<b>1</b>	<b>11</b>
	Addition and subtraction rule of differentiation and problems	<b>4</b>	<b>1,3,7</b>	<b>1</b>	
	Product rule and quotient rule of differentiation and problems	<b>4</b>	<b>1,3,7</b>	<b>1</b>	
	Product rule and quotient rule of differentiation and problems	<b>4</b>	<b>1,3,7</b>	<b>1</b>	
	Composite functions and their derivatives. (CHAIN RULE)	<b>4</b>	<b>1,3,7</b>	<b>1</b>	
	Composite functions and their derivatives. (CHAIN RULE). Problems	<b>4</b>	<b>1,3,7</b>	<b>1</b>	
	Successive differentiation up to second order	<b>4</b>	<b>1,3,7</b>	<b>1</b>	
	Slope of the tangent and normal to the given curve and their equations and problems	<b>4</b>	<b>1,3,7</b>	<b>1</b>	

	Rate measure: velocity and acceleration at a point of time and problems	4	1,3,7	1	
	Local Maxima and Minima of a function	4	1,3,7	1	
	Local Maxima and Minima of a function. Problems	4	1,3,7	1	
<b>5</b> <b>INTEGRAL CALCULUS AND APPLICATIONS</b>	Definition of an indefinite integral. Listing the Integrals of standard functions. (Algebraic, trigonometric, exponential, logarithmic and inverse trigonometric functions)	5	1,3,7	1	11
	Rules of Integration. Evaluation of integrals with simple integrands and their combinations	5	1,3,7	1	
	Rules of Integration. Evaluation of integrals with simple integrands and their combinations. Problems	5	1,3,7	1	
	Evaluation of integrals with simple integrands and their combinations. Problems	5	1,3,7	1	
	Evaluation of integrals by Substitution method	5	1,3,7	1	
	Evaluation of integrals by Integration by parts	5	1,3,7	1	
	Evaluation of integrals by Integration by parts. Problems	5	1,3,7	1	
	Definition of definite integrals and their evaluation	5	1,3,7	1	
	Evaluation of Definite integrals. Problems	5	1,3,7	1	
	Area enclosed by the curves by integral method	5	1,3,7	1	
	Volume generated by the curve rotated about an axis by integral method	5	1,3,7	1	

**First Semester Examination, Model Question Paper – 2020**  
**Engineering Mathematics**

Duration: 3Hours]

Subject Code: 20SC01T

[ Max. Marks:100

**Instruction:** Answer one full question from each section. One full question carries 20 marks.

**SECTION – 1**

- 1**
- a** If the matrix  $\begin{bmatrix} 2 & 4 & 6 \\ 2 & x & 2 \\ 6 & 8 & 14 \end{bmatrix}$  is singular then find  $x$  . **4**
- b** Find the  $A^2$  for the matrix  $\begin{bmatrix} 1 & 3 & 4 \\ -1 & 2 & 1 \\ 0 & 3 & 3 \end{bmatrix}$ . **5**
- c** Solve  $2x - y = 3$  and  $x + 2y = 4$  by using determinant method. **5**
- d** Find the inverse of the matrix  $\begin{bmatrix} 2 & 3 & 1 \\ -1 & 2 & 1 \\ 5 & 4 & 3 \end{bmatrix}$ . **6**
- 2**
- a** If  $A = \begin{bmatrix} 2 & -1 \\ 4 & 0 \\ 1 & 3 \end{bmatrix}$  and  $B = \begin{bmatrix} 1 & -3 & 4 \\ -1 & -1 & 1 \\ 0 & 4 & 2 \end{bmatrix}$  then find  $(AB)^T$ . **4**
- b** Verify whether  $AB=BA$  for the matrices  $A = \begin{bmatrix} 1 & 0 & 5 \\ -1 & 2 & 1 \\ 5 & 4 & 3 \end{bmatrix}$  and  $B = \begin{bmatrix} 3 & -1 & 4 \\ 0 & -1 & 1 \\ 2 & 4 & -2 \end{bmatrix}$ . **5**
- c** Find the Adjoint of the matrix  $A = \begin{bmatrix} 1 & 3 & 4 \\ -1 & 2 & 1 \\ 0 & 3 & 3 \end{bmatrix}$ . **5**
- d** Find the characteristic equation and eigen values for the matrix  $\begin{bmatrix} 1 & 2 \\ 3 & 1 \end{bmatrix}$ . **6**



## SECTION – 2

- 3**
- a** If the straight line is passing through the points (1, 2) and (3, 5) then find the slope of the line. **4**
- b** Write the standard intercept form of the straight line and hence find the equation of the straight line whose x and y intercepts are 2 and 3 respectively. **5**
- c** Write the standard slope-intercept form of a straight line. Find the equation of the straight line passing through the point (3, 5) and slope 4 units. **5**
- d** Find the equation of the straight line parallel to the line passing through the points (1, 3) and (4, 6). **6**
- 4**
- a** i) If a line inclined at  $45^\circ$  with x-axis find its slope. ii) Write the x and y intercept of the line  $2x+3y=10$ . **2+2**
- b** Find the equation of the straight line whose angle of inclination is  $45^\circ$  and passing through the origin. **5**
- c** Find the equation of the straight line perpendicular to the line  $2x+6y=3$  and with the y intercept 2 units. **5**
- d** Find the acute angle between the lines  $7x-4y=0$  and  $3x-11y+5=0$ . **6**

## SECTION – 3

- 5**
- a** Express  $75^\circ$  in radian measure and  $3\pi/2$  in degree. **4**
- b** Prove that  $\cos(A + B)\cos(A - B) = \cos^2 A - \sin^2 B$ . **5**
- c** Show that  $\cos 2\theta = 2\cos^2 \theta - 1$ . **5**

- d** Find the value of  $\sin 120^\circ \cdot \cos 330^\circ - \sin 240^\circ \cdot \cos 390^\circ$  without using calculator. **6**
- 6 a** Find the value of  $\sin 15^\circ$ . **4**
- b** Simplify  $\frac{\cos(360^\circ - A) \tan(360^\circ + A)}{\cot(270^\circ - A) \sin(90^\circ + A)}$ . **5**
- c** Prove that  $\sin 3\theta = 3\sin\theta - 4\sin^3\theta$ . **5**
- d** Prove that  $\sin 20^\circ \cdot \sin 40^\circ \cdot \sin 80^\circ = \frac{\sqrt{3}}{8}$ . **6**

**SECTION – 4**

- 7 a** Find the derivative of  $y = x^2 + e^{2x} + \cos 2x - 2 \log x$  with respect to  $x$ . **4**
- b** Find  $dy/dx$  of  $y = \frac{\sec x + \tan x}{\sec x - \tan x}$ . **5**
- c** Find  $dy/dx$  of  $y = \tan^{-1}\left(\frac{1+x}{1-x}\right)$ . **5**
- d** If the  $s = 2x^3 + 3x + 4$  represents the displacement of the particle in motion at time  $x$ , then find the velocity of the particle at  $x = 2$  secs and acceleration at  $x = 3$  secs. **6**
- 8 a** Find  $\frac{dy}{dx}$  of  $y = 3x^4 + 4 \log x + 2e^{3x} + \tan^{-1} x$ . **4**
- b** If  $y = e^{2x} \sin 3x$  then find  $\frac{dy}{dx}$ . **5**
- c** Find  $\frac{d^2y}{dx^2}$  if  $y = 3 \sin x + 4 \cos x$  at  $x = 1$ . **5**
- d** Find the equation of tangent and normal to the curve  $y = x^2$  at the point  $(1, 1)$ . **6**

## SECTION – 5

- 9 a** Evaluate  $\int (x-1)(x+1)dx$ . **4**
- b** Evaluate  $\int_0^{p/2} \sin^2 x dx$  **5**
- c** Evaluate  $\int x \sin x dx$ . **5**
- d** Find the area bounded by the curve  $y = 4x - x^2 - 3$ , x-axis and ordinates  $x = 1$  and  $x = 3$ . **6**
- 10 a** Evaluate  $\int_0^2 e^x dx$ . **4**
- b** Evaluate  $\int \frac{4 \cos(\log x)}{x} dx$ . **5**
- c** Evaluate  $\int x e^x dx$ . **5**
- d** Find the volume of the solid generated by revolving the curve  $y = \sqrt{x^2 + 5x}$  between  $x = 1$  and  $x = 2$ . **6**

\*\*\*\*\*

**Government of Karnataka**  
**Department of Collegiate and Technical Education**  
**Board of Technical Examinations, Bangalore**

<b>Course Code</b>	20CS11T	<b>Semester</b>	I
<b>Course Title</b>	<b>FUNDAMENTALS OF COMPUTER</b>	<b>Course Group</b>	Core
<b>No. of Credits</b>	4	<b>Type of Course</b>	Lecture
<b>Course Category</b>	PC	<b>Total Contact Hours</b>	4Hrs Per Week
			52Hrs Per Semester
<b>Prerequisites</b>	Nil	<b>Teaching Scheme</b>	(L: T:P) = 4:0:0
<b>CIE Marks</b>	50	<b>SEE Marks</b>	50

### 1. COURSE RATIONALE

Fundamentals of Computer is the foundational course that sets the base for computer science engineering. Core knowledge of number system, conversion, Boolean algebra, logic circuits are fundamental and even sets the basis for further study of computer organization & architecture, system software and computer network. Understanding the functional units, peripherals and components of a computer is vital.

### 2. COURSE SKILL SET

The aim of the course is to help the student to attain the following industry identified competency through various teaching –learning experiences

1. Identify computer hardware and software
2. Understand the data representation in computers
3. Basic knowledge of computer system and its working
4. Basic knowledge of logical thinking and problem solving

### 3. COURSE OBJECTIVES

1. Introduction to number system, conversion and data representation
2. Introduction to logic design
3. Understand functional units and components of computer
4. Develop logical thinking and problem-solving skills

**4. JOB ROLE**

SL.NO	LEVEL	JOB ROLES
1	3	Computer Operator & Program Assistant
2	3	Front Desk Operator
3	3	Office Assistant

**5. PREREQUISITES**

STUDENT	NIL
TEACHER	Various pedagogical techniques

**6. COURSE OUT COMES**

On successful completion of the course, the students will be able to demonstrate industry-oriented COs associated with the above-mentioned competency:

COURSE OUTCOME		CL	LINKED PO	TEACHING HOURS
CO1	Apply the knowledge of number system and Boolean algebra in computer system	U, A	1,4,7	12
CO2	Apply the knowledge of logic circuits for practical application	U, A	1,4,7	14
CO3	Recognize the various hardware and software associated with computer	U	1,7	8
CO4	Comprehend the functional units of a computer	U	1,7	10
CO5	Represent simple problems in terms of algorithm and flowchart	U, A	1,7	8

**7. SUGGESTED SPECIFICATION TABLE WITH HOURS & MARKS (THEORY)**

COURSE OUTCOME	Unit Linked	LINKED PO	TEACHING HOURS	DISTRIBUTION OF THEORY MARKS			
				R	U	A	TOTAL
CO1	1	1,4,7	12	10	30	10	50
CO2	2	1,4,7	14	10	30	10	50
CO3	3	1,7	8	5	20	5	30
CO4	4	1,7	10	10	20	10	40
CO5	5	1,7	8	5	20	5	30
<b>TOTAL</b>			<b>52</b>	<b>40</b>	<b>120</b>	<b>40</b>	<b>200</b>

**Legends:** R = Remember; U = Understand; A = Apply and above levels (Bloom’s revised taxonomy)

**8. INSTRUCTIONAL STRATEGY**

**These are sample strategies, which teacher can use to accelerate the attainment of the various course outcomes**

1. Massive Open online courses (MOOCS) can be used to teach various topics/subtopics.
2. Lecture method(L) does not mean only traditional lecture method, but different type of teaching methods and media can be employed to develop the outcomes.
3. About 15 to 20% of the topics/subtopics which are relatively simpler or descriptive in nature are to be given to the students for self-directed learning.
4. Arrange visits to nearby Offices/Industries/ Academic institution having network facility to understand types of network and types of computers being used.
5. Use different instructional strategies in classroom teaching
6. Use of virtual labs wherever mentioned

**5. DETAILS OF COURSE CONTENT**

The following topics/subtopics is to be taught and assessed in order to develop Unit Skill sets for achieving CO to attain identified skill sets

UNIT NO	TOPICS/SUBTOPICS	LEARNING OUTCOME (IN COGNITIVE DOMAIN)	HOURS L-T-P
1	<b>BASICS OF LOGIC DESIGN</b>		12
	1.1 Introduction to number system. <ul style="list-style-type: none"> <li>• Binary</li> <li>• Octal</li> <li>• Decimal</li> <li>• Hexadecimal</li> </ul> (characteristics of each number system)	1. Understand various number representation 2. Perform conversion and arithmetic operations using different number system 3. Apply the knowledge of codes to represent data	
	1.2 Conversion from one number system to other	4. Explain the working of logic gates	
	1.3 Complements of number systems and arithmetic operations	5. Apply Boolean rules and laws to solve the Boolean expression	
	1.4 Computer codes (BCD, EBCDIC, ASCII		

	Code, Gray code, Excess-3 code and Unicode) 1.5 Logic gates 1.6 Boolean algebra (rules, laws, De-Morgan Theorem, Boolean expressions and simplifications)		
	<b>Note:</b> <b>1. Use visual/graphic content for demonstration</b> <b>2. Demonstrate data representation inside the computer using virtual labs</b> <b>3. Demonstrate logic gates using virtual labs</b> <b>4. Explain with block diagram, circuit diagram and truth table</b>		
<b>2</b>	<b>LOGIC CIRCUITS</b>		<b>14</b>
	2.1 Combinational Circuits <ul style="list-style-type: none"> <li>▪ Characteristics</li> <li>▪ Logic circuit design</li> <li>▪ Block diagram, features &amp; Applications of</li> <li>▪ adders, subtractors and comparators</li> <li>▪ multiplexers, demultiplexers</li> <li>▪ encoders, decoders and code converters (7 segment)</li> </ul> 2.2 Sequential Circuits <ul style="list-style-type: none"> <li>▪ Characteristics</li> <li>▪ Types                         <ul style="list-style-type: none"> <li>▪ Asynchronous</li> <li>▪ Synchronous (clocked, unclocked)</li> </ul> </li> <li>▪ Flip flops                         <ul style="list-style-type: none"> <li>○ Types, circuit analysis and truth table</li> </ul> </li> <li>▪ Applications of sequential circuits                         <ul style="list-style-type: none"> <li>○ Shift registers (types and</li> </ul> </li> </ul>	1. Identify logic circuits 2. Describe the working of logic circuits 3. Compare combinational and sequential circuits 4. List the applications of logic circuits	

	<p>application)</p> <ul style="list-style-type: none"> <li>○ Counters (classification and application)</li> </ul>		
	<p><b>Note:</b>  <b>1. Demonstrate logic circuits and their application using virtual labs</b></p>		
<b>3</b>	<b>INTRODUCTION TO COMPUTER CONCEPTS</b>		<b>8</b>
	<p>3.1 Introduction to computers</p> <ul style="list-style-type: none"> <li>▪ Evolution of computer (abstract only)</li> <li>▪ Generation of computers</li> <li>▪ Classification of computer</li> <li>▪ Applications</li> </ul> <p>3.2 Components of computers</p> <ul style="list-style-type: none"> <li>▪ Hardware (different types of hardware components)</li> <li>▪ Software (System Software, Application Software, E-accessibility Software) (Open source, freeware and proprietary software)</li> <li>▪ Peripherals (working of keyboard and laser printer)</li> </ul> <p>3.3 Computer Network (Concept Only)</p> <ul style="list-style-type: none"> <li>▪ Basics</li> <li>▪ Categories</li> <li>▪ Protocols (Application layer)</li> <li>▪ Advantages.</li> </ul> <p>3.4 Methods of data processing (concepts only)</p> <ul style="list-style-type: none"> <li>▪ Single user programming</li> <li>▪ Multi programming</li> <li>▪ Real-time processing</li> <li>▪ On-line processing</li> </ul>	<p>1. Describe the characteristics of computer of various generations</p> <p>2. Identify the functional units and peripherals of a computer</p> <p>3. Identify components of a computer system</p> <p>4. Explain computer network concepts such as types, protocols</p> <p>5. Identify and distinguish threats and viruses</p>	



	<ul style="list-style-type: none"> <li>▪ Time sharing processing</li> <li>▪ Distributed processing</li> </ul> <p>3.5 Computer Security</p> <ul style="list-style-type: none"> <li>▪ Types of threats and source of threats</li> </ul>		
	<p><b>Note</b></p> <p><b>1. Demonstrate computer and computer software's using videos and other visual/graphical method</b></p>		
<b>4</b>	<b>INTRODUCTION TO COMPUTER ORGANIZATION &amp; OPERATING SYSTEM</b>		<b>10</b>
	<p>4.1 Introduction</p> <ul style="list-style-type: none"> <li>▪ Overview of functional units of a computer</li> <li>▪ Stored Program Concept</li> <li>▪ Flynn's Classification of Computers</li> </ul> <p>4.2 Memory Hierarchy</p> <ul style="list-style-type: none"> <li>▪ Main memory</li> <li>▪ Auxiliary memory</li> <li>▪ Cache memory</li> </ul> <p>4.3 Introduction to BIOS and UEFI</p> <p>4.4 OS Concepts</p> <ul style="list-style-type: none"> <li>▪ Overview</li> <li>▪ Types (Batch Operating System, Multitasking/Time Sharing OS, Multiprocessing OS, Real Time OS, Distributed OS, Network OS, Mobile OS)</li> <li>▪ Services</li> </ul>	<p>1.Examine the working of each functional unit</p> <p>2. Explain memory hierarchy</p> <p>3.Explain BIOS and UEFI</p> <p>4.Describe type and functions of OS</p>	
	<p><b>Note:</b></p> <p><b>1. Demonstrate using videos and other visual/graphical method</b></p>		
<b>5</b>	<b>INTRODUCTION TO COMPUTER PROGRAMMING</b>		<b>8</b>
	<p>5.1 Basics of programming</p> <ul style="list-style-type: none"> <li>▪ Algorithms and Flowcharts</li> <li>▪ Basics</li> <li>▪ Decision making</li> </ul>	<p>1.Writing algorithms for mathematical concepts</p> <p>2.Representation with flowchart</p> <p>3. Identify the naming rules for</p>	

	<ul style="list-style-type: none"> <li>▪ Iterative (With sufficient examples)</li> </ul> 5.2 Programming Languages <ul style="list-style-type: none"> <li>▪ Generation of languages</li> <li>▪ General concepts of variables and constants</li> </ul>	variables	
	<b>Note:</b> 1. Demonstrate using videos and other visual/graphical method 2. Use of online tools for flowchart design. ex: <a href="https://app.diagrams.net/">https://app.diagrams.net/</a>		

### 10. MAPPING OF CO WITH PO

COURSE	CO'S	PROGRAMME OUTCOMES (PO'S)						
		1	2	3	4	5	6	7
FUNDAMENTALS OF COMPUTERS	CO1	3	-	-	2	-	-	1
	CO2	3	-	-	2	-	-	1
	CO3	3	-	-	2	--	-	1
	CO4	3	-	-	2	-	-	3
	CO5	3	-	-	2	-	-	3
Level 3- Highly Mapped, Level 2-Moderately Mapped, Level 1-Low Mapped, Level 0- Not Mapped								

### 11. SUGGESTED LEARNING RESOURCES

BOOKS	
1	Digital fundamentals – Thomas L. Floyd, PEARSON EDUCATION publication, Eleventh edition – Global Edition, ISBN 10: 1-292-07598-8, ISBN 13: 978-1-292-07598-3
2	Digital Electronics –principles and integrated circuits. Anil K. Maini. Wiley publications, first edition. ISBN: 978-81-265-1466-3
3	Digital Electronics –principles and integrated circuits. Anil K. Maini. Wiley publications, first edition. ISBN: 978-81-265-1466-3
4	Digital principles and applications. Donald P Leach, Albert Paul Malvino, GoutamSaha, McGraw Hill Publisher, 7th edition, ISBN (13 digit): 978-0-07-014170-4 ISBN (10 digit): 0-07-014170-3
5	Digital Computer Fundamentals, - Thomas C Bartee, McGraw-Hill Publisher, 4th edition. ISBN 0-07-003892-9
6	Digital Logic and Computer Design M. Morris Mano

7	Introduction to Computer Science, ITL Education Solutions Pvt. Ltd., Pearson Education
8	“Computer Fundamentals” by Goel
<b>URL'S</b>	
1	<a href="https://www.tutorialspoint.com/basics_of_computer_science">https://www.tutorialspoint.com/basics of computer science</a>
2	<a href="https://www.guru99.com/operating-system-tutorial.html">https://www.guru99.com/operating-system-tutorial.html</a>
3	<a href="https://www.javatpoint.com/computer-organization-and-architecture-tutorial">https://www.javatpoint.com/computer-organization-and-architecture-tutorial</a>

**12. SUGGESTED LIST OF PROPOSED STUDENT ACTIVITIES**

Note: the following activities or similar activities for assessing CIE (IA)

SL. NO	ACTIVITY
1	Prepare a report on programming languages and their features
2	Prepare a report on open source and proprietary, system and application software
3	Prepare a report on recent viruses(computer)
4	Identify the logic circuits used in construction of memory and prepare a report
5	Identify the utilities of OS and prepare a report

**13. COURSE ASSESSMENT AND EVALUATION CHART**

SL.N O	ASSESSMENT	DURATION (in minutes)	MAX MARKS	CONVERSION
1	CIE Assessment 1 (Written Test -1) - At the end of 3 <sup>d</sup> week	80	30	Average of three written tests 30
2	CIE Assessment 2 (Written Test -2) - At the end of 7 week	80	30	
3	CIE Assessment 3 (Written Test -3) - At the end of 13 week	80	30	
4	CIE Assessment 4 (MCQ/Quiz)- At the end of 5 week	60	20	Average of three 20
5	CIE Assessment 5 (Open book Test) - At the end of 9 week	60	20	
6	CIE Assessment 6 (Student activity/ Assignment)- At the end of 11 week	60	20	
7	<b>Total Continuous Internal Evaluation (CIE) Assessment</b>			<b>50</b>

<b>8</b>	Semester End Examination (SEE) Assessment (Written Test)	<b>3 hrs</b>	<b>100</b>	<b>50</b>
<b>TOTAL MARKS</b>				<b>100</b>

**14. RUBRICS FOR ACTIVITY**

<b>RUBRICS FOR ACTIVITY (Example Only)</b>						
<b>Dimension</b>	<b>Poor</b>	<b>Below average</b>	<b>Average</b>	<b>Good</b>	<b>Exemplary</b>	<b>Student Score</b>
	<b>4</b>	<b>8</b>	<b>12</b>	<b>16</b>	<b>20</b>	
<b>Collection of data</b>	Does not collect any information relating to the topic	Collects very limited information; some relate to the topic	Collect much information; but very limited relate to the topic	Collects some basic information; most refer to the topic	Collects a great deal of information; all refer to the topic	8
<b>Fulfil team's roles &amp; duties</b>	Does not perform any duties assigned to the team role	Performs very little duties but unreliable.	Performs very little duties	Performs nearly all duties	Performs all duties of assigned team roles	6
<b>Shares work equally</b>	Always relies on others to do the work	Rarely does the assigned work; often needs reminding	Usually does the assigned work; rarely needs reminding	Normally does the assigned work	Always does the assigned work without having to be reminded.	8
<b>Listen to other Team mates</b>	Is always talking; never allows anyone else to speak	Usually does most of the talking; rarely allows others to speak	Talks good; but never show interest in listening others	Listens, but sometimes talk too much	Listens and speaks a fair amount	8
<b>Average / Total Marks: (8+6+8+8)/4</b>						<b>7.5 = 8 marks</b>

**Model Question Paper  
I A Test (CIE)**

<b>Programme:</b>		<b>Semester: I</b>			
<b>Course</b>	:	<b>Max Marks : 30</b>			
<b>Course Code</b>	:	<b>Duration : 1 Hr 20 minutes</b>			
<b>Name of the course coordinator:</b>		<b>Test : I/II/III</b>			
Note: Answer one full question from each section. One full question carries 10 marks.					
<b>Qn.No</b>	<b>Question</b>	<b>CL</b>	<b>CO</b>	<b>PO</b>	<b>Marks</b>
<b>Section-1</b>					
1.a)					
b)					
c)					
2.a)					
b)					
c)					

Section-2				
3.a)				
b)				
c)				
4.a)				
b)				
c)				
Section-3				
5.a)				
b)				
c)				
6.a)				
b)				
c)				

**Model Question Paper  
Semester End Examination**

<b>Programme:</b>	<b>Semester: I</b>
<b>Course :</b>	<b>Max Marks: 100</b>
<b>Course Code:</b>	<b>Duration: 3 Hrs</b>

**Instruction to the Candidate:**

Answer one full question from each section. One full question carries 20 marks.

Qn.No	Question	CL	CO	Marks
<b>Section-1</b>				
1.a)				
b)				
2.a)				
b)				
<b>Section-2</b>				
3.a)				
b)				
4.a)				
b)				
<b>Section- 3</b>				
5.a)				
b)				
6.a)				
b)				
<b>Section-4</b>				
7.a)				
b)				
8.a)				
b)				
<b>Section-5</b>				
9.a)				
b)				
10.a)				
b)				

**Government of Karnataka**  
**Department of Collegiate and Technical Education**  
**Board of Technical Examinations, Bangalore**

<b>Course Code</b>	20EC01P	<b>Semester</b>	I/II
<b>Course Title</b>	<b>FUNDAMENTALS OF ELECTRICAL &amp; ELECTRONICS ENGINEERING</b>	<b>Course Group</b>	Core
<b>No. of Credits</b>	4	<b>Type of Course</b>	Lecture & Practice
<b>Course Category</b>	PC	<b>Total Contact Hours</b>	6Hrs Per Week
			78Hrs Per Semester
<b>Prerequisites</b>	Basic Science	<b>Teaching Scheme</b>	(L: T:P) =1:0:2
<b>CIE Marks</b>	60	<b>SEE Marks</b>	40

### 1. RATIONALE

Fundamentals of Electrical and Electronics Engineering is essential for all streams of diploma engineering to work in any industry as it covers basic electrical safety, troubleshooting and repairing of simple electrical systems. Basic knowledge of electrical wiring circuits, protective devices, electrical machines and basic electronics devices is required to work in any engineering field.

### 2. COURSE SKILL SET

The aim of the course is to help the student to attain the following industry identified competency through various teaching –learning experiences

1. Perform and test domestic wiring
2. Can operate electrical machine
3. Test different electronics devices

### 3. INSTRUCTIONAL STRATEGY

1. Expose to different learning tools used in respective labs, Operational safety and Procedure to be followed in the laboratory.
2. Instructor should give examples from daily routine as well as, engineering/technology applications on various concepts and principles in each topic so that students are able to understand and grasp these concepts and principles. In all contents, SI units should be followed.
3. Activity- Theory - Demonstrate/practice approach may be followed throughout the course so that learning may be skill and employability based.

### 4. COURSE OUT COMES

*On successful completion of the course, the students will be able to*

<b>C01</b>	Comply with the safety procedures
<b>C02</b>	Apply the fundamentals of electricity.
<b>C03</b>	Install and test electrical wiring system.
<b>C04</b>	Identify and Operate electrical machines, Batteries and UPS.

<b>CO5</b>	Identify and test the different electronic devices.
------------	---

**5. COURSE TOPICS:**

Unit No	Unit Name	Hours
1	Electrical Safety	6
2	Electrical Fundamentals	15
3	Protective Devices and Wiring circuits	15
4	Electric Machines and Batteries and UPS	15
5	Introduction to Electronic Devices and Digital Electronics	27
<b>Total</b>		<b>78Hr</b>

**6. COURSE CONTENT**

*The following topics/subtopics is to be taught and assessed in order to develop Unit Skill sets for achieving CO to attain identified skill sets*

Sl No	Unit skill set (In cognitive domain) <i>On successful completion of the class, the students will be able to</i>	Topics/Subtopics	Practical	Hours L-T-P
<b>UNIT-1</b> <b>Electrical Safety</b>				
1	Comply with the Electrical safety	1. Electrical Symbols 2. Electrical safety <ul style="list-style-type: none"> <li>• Identify Various types of safety signs and what they mean</li> <li>• Demonstrate and practice use of PPE</li> <li>• Demonstrate how to free a person from electrocution</li> <li>• Administer appropriate first aid to victims, bandaging, heart attack, CPR, etc.</li> <li>• Fire safety, causes and precautionary activities.</li> <li>• Use of appropriate fire extinguishers on different types of fires.</li> <li>• Demonstrate rescue techniques applied during fire hazard, correct method to move injured people during emergency</li> <li>• Inform relevant authority about any abnormal situation</li> <li>• Earthing: Types</li> </ul>	1. Electrical symbols related to electrical engineering. 2. Electrical safety 3. Electrical earthing	02-00-04

		<ul style="list-style-type: none"> <li>➤ <a href="http://nreeder.com/Flash/symbols.htm">http://nreeder.com/Flash/symbols.htm</a></li> <li>➤ <a href="http://bouteloup.pierre.free.fr/iufm/as/de/house/safety.html">http://bouteloup.pierre.free.fr/iufm/as/de/house/safety.html</a></li> </ul>		
<b>UNIT-2</b> <b>Electrical Fundamentals</b>				
2	<ol style="list-style-type: none"> <li>1. Identify and select the different measuring devices.</li> <li>2. Identify different electrical supply systems</li> <li>3. Identify open circuit, close circuit and short circuit conditions.</li> </ol>	<ol style="list-style-type: none"> <li>1. Describe the sources of electrical energy.</li> <li>2. Electrical current, voltage, emf, potential difference, resistance with their SI units.</li> <li>3. Mention the meters used to measure different electrical quantities.</li> </ol> <p>Identification Measuring devices</p> <ul style="list-style-type: none"> <li>• Ammeter</li> <li>• Voltmeter</li> <li>• Wattmeter</li> <li>• Ohmmeter</li> <li>• Digital Multimeter</li> <li>• Megger</li> <li>• Tong tester</li> </ul> <ol style="list-style-type: none"> <li>4. Explain supply systems like AC, DC.</li> </ol> <ul style="list-style-type: none"> <li>➤ <a href="http://nreeder.com/Flash/units.htm">http://nreeder.com/Flash/units.htm</a></li> </ul>	<ol style="list-style-type: none"> <li>1. Connect voltmeter and ammeter in a simple circuit. (Practicing of identification and connection of different meters)</li> </ol>	1:0:2
3	Calculate basic electrical quantities	<ul style="list-style-type: none"> <li>• Relationship between V, I and R. (Ohms law)</li> <li>• Behavior of V, I in Series and Parallel DC circuits.</li> <li>• Describe open circuit, close circuit and short circuit</li> </ul> <ul style="list-style-type: none"> <li>• <a href="http://nreeder.com/Flash/ohmsLaw.htm">http://nreeder.com/Flash/ohmsLaw.htm</a></li> </ul>	<ol style="list-style-type: none"> <li>1. Measure current, voltage and analyze effective resistance in series circuit</li> <li>2. Demonstrate effects of shorts and opens in a circuit</li> </ol>	1:0:2
4	Connect resistances in different combination	<ol style="list-style-type: none"> <li>1. Equation to find the effective Resistances connected in series</li> <li>2. Equation to find effective Resistances connected in parallel</li> <li>3. Resistances connected series and parallel combinations</li> <li>4. Simple problems.</li> </ol>	<ol style="list-style-type: none"> <li>1. Determine the equivalent Resistance of parallel connected resistances.</li> </ol>	1:0:2
5	Calculate and measurement of different parameters of an AC quantity.	<p><b>Ac sinewave:</b> Sinusoidal voltage, current, amplitude, time-period, cycle, frequency, phase, phase difference, and their units.</p> <ul style="list-style-type: none"> <li>➤ <a href="http://nreeder.com/Flash/freqPeriod.htm">http://nreeder.com/Flash/freqPeriod.htm</a></li> <li>➤ <a href="http://nreeder.com/Flash/oscill">http://nreeder.com/Flash/oscill</a></li> </ul>	<p>Generate and demonstrate the measurement of frequency, time period and phase difference of</p>	1:0:2



		<a href="#">oscope.htm</a>	AC quantity using CRO and function generator.	
6	<ol style="list-style-type: none"> <li>Calculate and measure electric power and energy</li> <li>Identify and differentiate Single phase and Three phase supply</li> </ol>	<ol style="list-style-type: none"> <li>Electrical work, power and power factor                             <ul style="list-style-type: none"> <li>SI units</li> <li>Mention the meters used to measure them</li> </ul> </li> </ol> <p>➤ <a href="http://nreeder.com/Flash/powerLaw.htm">http://nreeder.com/Flash/powerLaw.htm</a></p>	<ul style="list-style-type: none"> <li>Measure the voltage, current, power using relevant measuring instruments in a Single-phase load.</li> </ul>	1:0:2
7.		<ol style="list-style-type: none"> <li>Electrical energy                             <ul style="list-style-type: none"> <li>SI units</li> <li>Mention the meters used to measure them</li> </ul> </li> <li>Single phase and Three phase supply.</li> </ol>	<ol style="list-style-type: none"> <li>Measure single phase energy using relevant measuring instruments in a Single-phase load.</li> <li>Measure the voltages in Three phase supply.</li> </ol>	
<b>UNIT-3</b>				
<b>Protective Devices and Wiring circuits</b>				
8.	<ol style="list-style-type: none"> <li>Identify and select Protective Devices for given current and voltage rating</li> <li>Identify and select the various electrician tools</li> </ol>	<ul style="list-style-type: none"> <li>Necessity of Protective Devices</li> <li>Various Protective devices and their functions</li> <li>fuse wire,</li> <li>Glass cartridge fuse</li> <li>HRC fuse</li> <li>Kit-kat fuse</li> <li>MCB</li> <li>MCCB</li> <li>RCCB</li> <li>ELCB</li> <li>Relay</li> <li>Different types of electrician tools and their function.</li> <li>Describe various wiring tools.</li> <li>State procedure of care and maintenance of wiring tools.</li> </ul>	<ol style="list-style-type: none"> <li>Wire up and test PVC Conduit wiring to control one lamp from two different places using suitable protective devices.</li> </ol>	1:0:2

9	<ol style="list-style-type: none"> <li>1. Identify and select Wiring systems for a given applications</li> <li>2. Identify and select the cables used for different current and voltage ratings.</li> <li>3. Draw the wiring diagram</li> </ol>	<ol style="list-style-type: none"> <li>1. Describe different types of wiring systems. <ul style="list-style-type: none"> <li>• Surface conduit</li> <li>• concealed conduit</li> <li>• PVC casing capping</li> </ul> </li> <li>2. Wiring systems and their applications.</li> <li>3. Describe the types of wires, cables used for different current and voltage ratings.</li> </ol>	<ol style="list-style-type: none"> <li>1. Wire up and test PVC Conduit wiring to control of 2 sockets and 2 lamps.</li> </ol>	2:0:4
10	Estimate and plan electrical wiring	Explain Plan and estimate the cost of electrical wiring for one 3m × 3m room consisting of 2 lamps, 1 ceiling fan, 2 three pin sockets.	Prepare the estimation and plan	1:0:2
<b>UNIT-4</b> <b>Electrical Machines and Batteries and UPS</b>				
11	<ol style="list-style-type: none"> <li>1. Identify the types of transformer.</li> <li>2. verify the transformation ratio.</li> </ol>	<b>Transformer</b> <ul style="list-style-type: none"> <li>• working principle</li> <li>• Transformation ratio</li> <li>• Types and applications with their ratings</li> </ul>	Connect the Single- phase transformer as Step-Up, Step-Down transformer and verify the transformation ratio.	1:0:2
12	<ol style="list-style-type: none"> <li>1. Start and run the induction motor.</li> <li>2. Troubleshoot DOL/Star-delta starter and induction motor</li> </ol>	<ol style="list-style-type: none"> <li>1. <b>Induction motor</b> <ul style="list-style-type: none"> <li>• Single phase and three phase Induction motor.</li> <li>• Necessity of starters.</li> <li>• Describe DOL AND STAR-DELTA starters.</li> </ul> </li> <li>2. What are different causes and remedies for a failure of starter and induction motor.</li> </ol>	<ol style="list-style-type: none"> <li>1. Construct a suitable circuit to start and reverse the direction of three phase induction motor using DOL/ Star-delta starter.</li> <li>2. Troubleshoot the DOL/ Star-delta starter and induction motor</li> </ol>	2:0:4
13	Select and test the battery for a given application	<b>Battery</b> <ul style="list-style-type: none"> <li>• Types of batteries (Lead acid battery, lithium, sealed maintenance free (SMF) battery, Modular battery).</li> <li>• Selection criteria of batteries for different applications.</li> <li>• Ampere-Hour Capacity.</li> <li>• Efficiency</li> </ul>	Testing Condition of charging and discharging of a Lead-acid battery	1:0:2
14	Select the size of the UPS for a given application	<b>UPS</b> <ul style="list-style-type: none"> <li>• List the types and applications</li> <li>• Selection criteria of UPS</li> <li>• Sizing of UPS</li> </ul>	Sizing of UPS	1:0:2

UNIT-5 Introduction to Electronic Devices and Digital Electronics				
15	Identify and differentiate Conductors, insulators and semiconductors.	1. Compare Conductors, insulators and semiconductors with examples. 2. Identification of types and values of resistors-color codes.  ➤ <a href="http://nreeder.com/Flash/resistor.htm">http://nreeder.com/Flash/resistor.htm</a>	Determine the value of resistance by color code and compare it with multimeter readings.	1:0:2
16	Identify and test PN junction Diode	<b>PN junction diode</b> <ul style="list-style-type: none"> <li>• Symbol</li> <li>• Characteristics</li> <li>• Diode as switch.</li> <li>• Types of diodes and ratings</li> <li>• Applications</li> </ul>	Identify the terminals of a Diode and test the diode for its condition.	1:0:2
17	Build and test bridge rectifier circuit	<b>Rectifier</b> <ul style="list-style-type: none"> <li>• Need for AC to DC conversion</li> <li>• Bridge rectifier with and without C filter,</li> <li>• Rectifier IC.</li> </ul>	Construct and test bridge rectifiers using semiconductor diode and rectifier IC. Compare the waveforms using CRO.	1:0:2
18	1. Identify and test Transistor 2. Build and test transistor as an electronic switch	<b>Transistor (BJT)</b> <ul style="list-style-type: none"> <li>• Symbol</li> <li>• Structure</li> <li>• Working principle</li> </ul>	1. Identification of transistor terminals and test. 2. Construct and test the transistor as an electronic switch	1:0:2
19.	1. Identify and test different digital IC	<ul style="list-style-type: none"> <li>• Comparison of analog and digital signal</li> <li>• Digital systems, examples.</li> <li>• Binary numbers, Boolean identities and laws.</li> <li>• Digital system building blocks: Basic logic gates, symbols and truth tables.</li> </ul> IC-Definition and advantages.	<ul style="list-style-type: none"> <li>• Test a Digital IC.</li> <li>• Identification and selection of suitable ICs for basic gates.</li> </ul> 1. Verify NOT, AND, OR, NOR, EXOR and NAND gate operations (two inputs).	2:0:4
20	Identify and test various Sensors and actuators.	<b>1.Sensors</b> <ul style="list-style-type: none"> <li>• Concept</li> <li>• Types: Temperature, Pressure, Water, Light, Sound, Smoke, proximity Sensors, Flow, humidity, voltage, vibration, IR (Principle/working, ratings/specifications, cost, and applications)</li> </ul> <b>2.Actuators</b> <ul style="list-style-type: none"> <li>• Concept</li> <li>• Types and applications.</li> <li>• Relay as an actuator.</li> </ul>	2. Connect and test an IR proximity sensor to a Digital circuit. <ul style="list-style-type: none"> <li>• Connect and test a relay circuit using an Opto-coupler. (Photo Diode &amp; Transistor)</li> </ul> <b>Refer note</b>	2:0:4

21	Know the application of Microcontroller and PLC	<ul style="list-style-type: none"> <li>• Microcontroller as a programmable device, and list of real-world applications.</li> <li>• PLC and Their applications.</li> </ul> (Activity based learning)	<ul style="list-style-type: none"> <li>• Identify different application microcontroller.</li> <li>• Identify commercially available PLC and their specifications</li> </ul>	1:0:2
<b>TOTAL</b>				<b>26-0-52=78 Hours</b>

### 7. PRATICAL SKILL EXERCISES

Sl. No.	Practical Out Comes/Practical exercises	Unit No.	PO	CO	L: T:P Hrs.
1	<ul style="list-style-type: none"> <li>• Identify Various types of safety signs and what they mean Demonstrate and practice use of PPE</li> <li>• Demonstrate how to free a person from electrocution appropriate first aid to victims, bandaging, heart attack, CPR, etc.</li> <li>• Fire safety, causes and precautionary activities.</li> <li>• Use of appropriate fire extinguishers on different types of fires.</li> <li>• Demonstrate rescue techniques applied during fire hazard.</li> <li>• Inform relevant authority about any abnormal situation during fire hazard.</li> </ul>	1	1,4	1	0:0:2
2	<ul style="list-style-type: none"> <li>• Demonstrate different types of earthing/using videos.</li> <li>• Prepare a Report on types of Earthing</li> </ul>	1	1,4	1	0:0:2
3	Connect voltmeter and ammeter in a simple circuit. (Practicing of identification and connection of different meters)	2	1,4	2	0:0:2
4	1.Determine the equivalent Resistance of series connected resistances. 2.Demonstrate effects of shorts and opens in a circuit	2	1,4	2	0:0:2
5	Determine the equivalent Resistance of parallel connected resistances.	2	1,4	2	0:0:2
6	Generate and demonstrate the measurement of frequency, time period and phase difference of AC quantity using CRO and function generator.	2	1,4	2	0:0:2
7	Measure the voltage, current, power using relevant measuring instruments in a Single-phase load.	2	1,4	2	0:0:2
8.	1.Measure single phase energy using relevant measuring instruments in a Single-phase load.				

	2. Measure the voltages in Three phase supply.				
9.	Wire up and test PVC Conduit wiring to control one lamp from two different places using suitable protective devices.	3	1,4	3	0:0:2
10	2. Wire up and test PVC Conduit wiring to control of 2 sockets and 2 lamps.	3	1,4	3	0:0:2
11	Wire up and test PVC Conduit wiring to control one lamp from two different places.	3	1,4	3	0:0:2
12	Plan and estimate the cost of electrical wiring for one 3mx3m room consisting of 2 CFL 1ceiling fan, 2 three pin sockets.	3	1,4	3	0:0:2
13	Connect the Single- phase transformer as Step-Up, Step-Down transformer and verify the transformation ratio.	4	1,4	4	0:0:2
14	Construct a suitable circuit to start and reverse the direction of three phase induction motor using DOL/star-delta starter.	4	1,4	4	0:0:2
15	Troubleshoot the DOL/Star-delta starter and induction motor	4	1,4	4	0:0:2
16	Testing Condition of charging and discharging of a Lead-acid battery.	4	1,4	4	0:0:2
17	Estimate the UPS rating for a computer lab with 50 computers/domestic.	4	1,4	4	0:0:2
18	Determine the value of resistance by color code and compare it with multimeter readings	5	1,4	5	0:0:2
19	Identify the terminals of a Diode and test the diode for its condition.	5	1,4	5	0:0:2
20	Construct and test bridge rectifiers using semiconductor diode and rectifier IC. Compare the waveforms using CRO.	5	1,4	5	0:0:2
21	Identification of transistor terminals and test. Construct and test the transistor as an electronic switch.	5	1,4	5	0:0:2
22	Test an IC. Verify the truth-table AND, OR, NOT logic gates.				
23	Verify the truth-table NAND, NOR, EX-OR, EX-NOR logic gates.	5	1,4	5	0:0:2
24	Connect and test anIR proximity sensor to a Digital circuit. <b>NOTE:</b> Any sensor listed in the theory may be used for condition appropriately.				
25	Connect and test a relay circuit using an Optocoupler. (Photo Diode & Transistor)	5	1,4	5	0:0:2
26	1. Identify MCS-51 variants 2. Identify commercially available PLC and their specifications.	5	1,4	5	0:0:2
<b>Total</b>					<b>0:0:52 =52Hrs</b>

### 8.MAPPING OF CO WITH PO

CO	Course Outcome	PO Mapped	Experiment	Cognitive Level R/U/A	Lecture & Practical Sessions in Hrs	TOTAL
C01	Comply with the safety procedures	PO1, PO4	1-2	A	6	
C02	Apply the fundamentals of electricity.	PO1, PO4	3-7	A	15	
C03	Install and test electrical wiring system and protective devices.	PO1, PO4	8-12	A	15	
C04	Identify and Operate electrical machines, Batteries and UPS.	PO1, PO4	13-17	A	15	
C05	Identify and test the different electronic devices.	PO1, PO4	18-26	A	27	

Course	CO's	Programme Outcomes (PO's)						
		1	2	3	4	5	6	7
<b>Fundamentals of Electrical and Electronics Engineering</b>	CO1	3	0	0	3	0	0	0
	CO2	3	0	0	3	0	0	0
	CO3	3	0	0	3	0	0	0
	CO4	3	0	0	3	0	0	0
<b>Level 3- Highly Mapped, Level 2-Moderately Mapped, Level 1-Low Mapped, Level 0-Not Mapped</b>								

### 9. SUGGESTED LEARNING RESOURCES:

**Reference Books:**

1. ABC of Electrical Engineering by B. L. Theraja and A. K. Theraja, S Chand Publishers, New Delhi, 2014 Edition.
2. Basic Electrical and Electronics Engineering by S. K. Bhattacharya, Pearson Education India, 2012 Edition.
3. Electronic Devices and Circuits by I. J. Nagrath, PHI Learning Pvt. Ltd., 2007 Edition.
4. Basic Electrical Engineering by V. Mittle and Arvind Mittle, McGrawHill Companies, 2005 Edition.
5. The 8051 Microcontroller & Embedded systems by Susinkbnnjbbh bb vvvvg assembly and C (2nd Edition) – M.A. Mazidi, J.C. Mazidi & R.D. McKinlay ISBN: 81-317-1026-2
6. Programmable Logic controllers, W BOLTON

**e-Resources**

1. [https://www.youtube.com/watch?v=mc9790hitAg&list=PLWv9VM947MKi\\_7yJ0\\_FCfzTBXpQU-Qd3K](https://www.youtube.com/watch?v=mc9790hitAg&list=PLWv9VM947MKi_7yJ0_FCfzTBXpQU-Qd3K)
2. <https://www.youtube.com/watch?v=CWulQ1ZSE3c>
3. [en.wikipedia.org/wiki/Transformer](http://en.wikipedia.org/wiki/Transformer)
2. [www.animations.physics.unsw.edu.au//jw/AC.html](http://www.animations.physics.unsw.edu.au//jw/AC.html)
3. [www.alpharubicon.com/altenergy/understandingAC.htm](http://www.alpharubicon.com/altenergy/understandingAC.htm)
4. [www.electronics-tutorials](http://www.electronics-tutorials)

5. [learn.sparkfun.com/tutorials/transistors](http://learn.sparkfun.com/tutorials/transistors)
6. [www.pitt.edu/~qiw4/Academic/ME2082/Transistor%20Basics.pdf](http://www.pitt.edu/~qiw4/Academic/ME2082/Transistor%20Basics.pdf)
7. [www.technologystudent.com/elec1/transis1.htm](http://www.technologystudent.com/elec1/transis1.htm)
8. [www.learningaboutelectronics.com](http://www.learningaboutelectronics.com)
9. [www.electrical4u.com](http://www.electrical4u.com)
10. [https://www.youtube.com/watch?v=zLW\\_7TPf310](https://www.youtube.com/watch?v=zLW_7TPf310)
11. <https://www.youtube.com/watch?v=8PTNjw-hQIM>

## 10. SUGGESTED LIST OF STUDENTS ACTIVITIES for CIE

**Note: the following activities or similar activities for assessing CIE (IA) (Any one)**

Each student should conduct different activity and no repeating should occur

1	Using suitable meters/ instruments give the practical working circuits to measure
2	Resistance, Current, Voltage, Power and Energy in DC and AC (Single phase) Circuits.
3	List out the different types of wiring systems used in your laboratories or house with their representation.
4	Mini-Projects: Like preparing extension box, switch box and wiring models,
5	List out the different protective devices used in your laboratories or house with their ratings.
6	Applications of Electro Magnetic Induction, statically induced and dynamically induced emf, self and mutual induced emfs.
7	Prepare a report on types of starters and enclosures used for various industrial applications of AC motors.
8	Types of Cells and Battery maintenance
9	Visit nearby Battery charging shop or show room and prepare a report of the visit.
10	Prepare a report on various types of diodes used for various industrial applications.
11	Prepare a report on various types of sensors and actuators used for various industrial applications.
12	Mini-Projects: Connect and test a sensor (domain application) to a Digital circuit

## 11. COURSE ASSESSMENT AND EVALUATION CHART

Sl.No	Assessment	Duration	Max marks	Conversion	
1.	CIE Assessment 1 (Written Test -1-theory) - At the end of <b>3<sup>rd</sup> week</b>	60 minutes	20	Average of two written tests 20	
2.	CIE Assessment 2 (Written Test -2-theory) - At the end of <b>13<sup>th</sup> week</b>	60 minutes	20		
3.	CIE Assessment 3 (Skill test) - At the end of <b>5<sup>th</sup> week</b>	3 Hours	100	20	Average of three skill tests 20
4.	CIE Assessment 4 (Skill test) - At the end of <b>7<sup>th</sup> week</b>	3 Hours	100		
5.	CIE Assessment 5 (Skill test) - At the end of <b>9<sup>th</sup> week</b>	3 Hours	100		
6.	CIE Assessment 6 (Student activity) - At the end of <b>11<sup>th</sup> week</b>	-	20	20	

7.	Total Continuous Internal Evaluation (CIE) Assessment			60
8.	Semester End Examination (SEE) Assessment (Practical Test)	3 Hours	100	40
<b>Total Marks</b>				<b>100</b>

**Note:**

1. CIE written test is conducted for 20 marks (Two sections). Each section shall have two full questions of same CL, CO. Student shall answer one full question (10 marks) from each section.
2. CIE Skill test is conducted for 100 marks (3 Hours duration) as per scheme of evaluation and the obtained marks are scaled down to 20 marks

**12. SCHEME OF VALUATION FOR SKILL TEST (CIE) & SEE**

**(CONTINUOUS INTERNAL & SEMESTER END EXAMINATION)**

Sl. No.	Particulars	Marks
1.	Identification of meters/ equipment/wires/tools etc.	10
2.	Writing Circuit/writing diagram and Procedure*	25
3.	Conduction	35
4.	Results	10
5.	Viva-voce	20
<b>Total</b>		<b>100</b>

**12. RUBRICS FOR ACTIVITY**

<b>RUBRICS FOR ACTIVITY (Example only)</b>						
<b>Faculty need to develop appropriate rubrics for respective activity</b>						
Dimension	Beginning	Developing	Satisfactory	Good	Exemplary	Student Score
	1	2	3	4	5	
<b>Collection of data</b>	Does not collect any information relating to the topic	Collects very limited information; some relate to the topic	Collect much information; but very limited relate to the topic	Collects some basic information; most refer to the topic	Collects a great deal of information; all refer to the topic	
<b>Fulfil team's roles &amp; duties</b>	Does not perform any duties assigned to the team role	Performs very little duties but unreliable.	Performs very little duties	Performs nearly all duties	Performs all duties of assigned team roles	



<b>Shares work equally</b>	Always relies on others to do the work	Rarely does the assigned work; often needs reminding	Usually does the assigned work; rarely needs reminding	Normally does the assigned work	Always does the assigned work without having to be reminded.	
<b>Listen to other Team mates</b>	Is always talking; never allows anyone else to speak	Usually does most of the talking; rarely allows others to speak	Talks good; but never show interest in listening others	Listens, but sometimes talk too much	Listens and speaks a fair amount	
<b>Average / Total Marks:</b>						

### Lab Equipment Requirement

*The following are the specification of the apparatus required for FEEE lab and number of apparatus required for the batch of 20 students.*

Sl. No.	Name of Equipment and Specification	Quantity Required
1	Dual Channel 30 V, 2 A continuously variable DC Regulated Power Supply with Current and Overload Protection	05 Nos.
2	+/- 15 V, 2 A, fixed DC Regulated Power Supply	05 Nos.
3	Portable Moving Coil DC Voltmeters a) 0 - 1 V b) 0 - 10 V c) 0 - 30 V	Each 05 Nos.
4	Portable Moving Iron AC Voltmeters a) 0 - 300 V b) 0 - 600 V	Each 05 Nos.
5	Portable Moving Coil DC Ammeters a) 0 - 100 mA b) 0 - 1 A c) 0 - 2 A	Each 05 Nos.
6	Portable Moving Iron AC Ammeters a) 0 - 2 A b) 0 - 5 A c) 0 - 10 A	Each 05 Nos.
7	Watt-meters a) 150/ 300V, 2 A, UPF b) 300/ 600 V, 5/ 10 A, LPF	Each 02 Nos.
8	Rheostats – 25 Ohms, 50 Ohms, 150 Ohms, 220 Ohms (all rated at 3 A)	Each 05 Nos.
9	Rheostat Loads s – 1 KW, 230 V	02 Nos.

10	Wire wound Resistors- 5 Ohms 2 Watts, 25 Ohms 5 Watts, 330 Ohms 2 Watts, 560 Ohms 2 Watts, etc.	Each 05 Nos.
11	Soldering Iron 60 W	05 Nos.
13	Single Phase Energy meter 10 A, 230 V, 50 Hz, Digital type	05 Nos.
14	Multi-meter Digital ¾"	06 Nos.
15	Dual Trace Oscilloscope – 30 MHz	02 Nos.
16	Three Phase Induction Motors :1 HP – 440 V 50 Hz, 2 HP – 440 V 50 Hz.	Each 02 Nos.
17	Three phase DOL, Star-Delta, Auto transformer starter	Each 02 Nos.
18	UPS 1 KVA	01 Nos.
19	Battery Lead-Acid type, 140 A-hr and Hydrometers	02 Nos.

Sl. No.	Name of Equipment and Specification	Quantity Required
20	I C Trainer kit	05 Nos
21	Digital IC's 7400, 7402, 7404, 7408, 7486 etc	Each 10 Nos.
22	Wooden Wiring board (2x3) ft	10
23	Wiring accessories	
2	<ul style="list-style-type: none"> <li>a) PVC conduit - ¾" - 10 lengths</li> <li>b) Cap and casing - ¾" - 10 lengths</li> <li>c) Switches Single Pole- 5A, 230 V</li> <li>d) Switches two way – 5 A, 230 V</li> <li>e) 3 Pin Sockets 5A, 230 V</li> <li>f) Bulb Holders – 5 A, 230 V</li> <li>g) 3 Pin Plug 5A, 230 V</li> <li>h) 60 Watts Lamps</li> <li>i) 100 Watts Lamps</li> <li>j) 15 W CFL lamps</li> <li>k) Copper Wires of sizes 1.5 mm<sup>2</sup>, 2.5 mm<sup>2</sup>, 4 mm<sup>2</sup> – 1 coil each</li> <li>l) Gang boxes (1+1, 2+1, 2+2)</li> <li>m) Kit –Kat fuses 5A, 15 A</li> <li>n) MCB 16 A &amp; 32 A/ 230 V, Single and Double Pole</li> <li>o) ELCB 16 A &amp; 32 A/ 230 V, Double Pole</li> <li>p) Neutral link- 16 A, 230 V</li> <li>q) Screws of assorted sizes</li> <li>r) Testers</li> </ul>	Each 10 Nos.

24	<p>Electronic Components</p> <ul style="list-style-type: none"> <li>a) Diodes - BY 127 and IN 4001</li> <li>b) Zener Diodes – 6.2 V, 5.6 V, 7.8 V</li> <li>c) Relays – solid state Sugar cube type, SPST, Coil 6V, Power circuit 230 V, 5 A.</li> <li>d) Spring Boards</li> <li>e) Bread Boards</li> <li>f) Tag Boards.</li> </ul>	Each 10 Nos.
25	<p>Simple PANEL BOARD/ CUBICAL consisting of bus-bars, CB/MCB/ELCB, meters, HRC fuses, magnetic contactors, cables, earthing points.</p>	1 No

## Government of Karnataka

## Department of Collegiate and Technical Education

## Board of Technical Examinations, Bangalore

<b>Course Code</b>	20CS01P	<b>Semester</b>	I/II
<b>Course Title</b>	<b>IT SKILLS</b>	<b>Course Group</b>	ES/CS
<b>No. of Credits</b>	4	<b>Type of Course</b>	Lecture + Practice
<b>Course Category</b>	ES	<b>Total Contact Hours</b>	6Hrs Per Week
			78Hrs Per Semester
<b>Prerequisites</b>	Basic Computer Skills	<b>Teaching Scheme</b>	(L:T:P)= 1:0:2
<b>CIE Marks</b>	60	<b>SEE Marks</b>	40

**1. RATIONALE**

Information Technology is crucial to the majority of the business and has a great influence on innovation and engineering. Every branch of engineering and every organization opt for computers and IT skills for business automation, communication/connectivity, resource planning, work automation and securing information etc. All engineering diploma students must be conversant with the basic IT skills which empower them to learn new technologies, adapt to changes, business development, communication etc.

**2. COURSE SKILL SET**

The aim of the course is to help the student to attain the following industry identified competency through various teaching –learning experiences.

Perform jobs related to web design and maintenance, business process automation tool management, cyber security and safety and program assistant.

**3. COURSE OBJECTIVES**

1. Demonstrate the basics of coding.
2. Design and develop web pages that include static and dynamic content.
3. Describe the basic concepts of Cloud and IoT.
4. Express the workflow and business automation
5. Recognize the best practices of Cyber Safety and security.

#### 4. JOB ROLE

SL.NO	LEVEL	JOB ROLES
1	3	Junior software developer - web.
2	3	Junior Creative Designer/Digital Artist

#### 5. PREREQUISITES

STUDENT	Basic Computer skills (Students without basic computer skills should be taught basic skills)
TEACHER	Computer science faculty with required knowledge of IT Skills.

#### 6. COURSE OUT COMES

On successful completion of the course, the students will be able to demonstrate industry oriented Cos associated with the above mentioned competency:

COURSE OUTCOME		UNIT LINKED	CL	LINKED PO	TEACHING HOURS
CO1	Illustrate the basics of coding and develop simple applications for android phones.	1	U, A	1,4,7	15
CO2	Design and Develop websites.	2	U, A	1,4,7	30
CO3	Identify Cloud Services IoT applications	3	U	1,4,7	12
CO4	Apply workflow and use ERP for a simple project plan	4	U	1,4,7	09
CO5	Implement best practices of cyber safety and security in the workplace.	5	U, A	1,4,7	12
<b>TOTAL</b>					<b>78</b>

## 8. INSTRUCTIONAL STRATEGY

**These are sample strategies, which teacher can use to accelerate the attainment of the various course outcomes**

1. Lecturer method(L) does not mean only traditional lecture method, but different type of teaching method and media visual/graphical content that are employed to develop the outcomes
2. Massive Open on-line courses (MOOCS) can be used to teach various topics/subtopics.
3. Online coding platform wherever mentioned.
4. Hands on coding should be practiced.
5. About 15 to 20% of the topics/subtopics which are relatively simpler or descriptive in nature is to be given to the students for self-directed learning

## 9. DETAILS OF COURSE CONTENT

The following topics/subtopics is to be taught and assessed in order to develop Unit Skill sets for achieving CO to attain identified skill sets

UNIT NO	Topics/Sub topics	Unit skill set/Learning outcomes (In cognitive domain)	Hours L-T-P
1	<b>UNIT 1 - INTRODUCTION TO BASICS OF CODING</b>		05-0-10
	1.1 Introduction to computer programming 1.2 Algorithms –With sufficient examples 1.3 Flowcharts – With sufficient examples 1.4 Execute simple programs <b>Note: Below listed or any other suitable online/offline coding platforms should be used to demonstrate and provide coding experience to students.</b> a. <a href="https://scratch.mit.edu/">https://scratch.mit.edu/</a>	1. Understand computer programming 2. Create and write Algorithm for programmable problems. 3. Design Flowchart for programmable problems. 4. Develop simple Android application.	

	<p><b>b.</b> <a href="https://studio.code.org/projects">https://studio.code.org/projects</a></p> <p>Suggested programs are listed in Table 1</p> <p>1.5 Introduction to Application development</p> <p>1.6 Simple android application development (No knowledge of programming language is required).</p> <p><b>Note:</b></p> <p><i>i. The purpose of application development is to ignite and promote programming skills.</i></p> <p><i>ii. Application development should be done using any App builder platforms such as</i></p> <p><i>iii. MITApp <span style="float: right;">Inventor:</span> <a href="https://appinventor.mit.edu/">https://appinventor.mit.edu/</a></i></p> <p><i>iv. Thinkable: <a href="https://thinkable.com/">https://thinkable.com/</a></i></p> <p><i>v. ibuildapp: <a href="https://ibuildapp.com/">https://ibuildapp.com/</a></i></p> <p><i>vi. The student should be introduced to the android application development environment for further research and learning <a href="https://developer.android.com/">https://developer.android.com/</a></i></p> <p>1.7 Activity: create a simple Android application (Unique for each student) publish on the learning management system.</p>		
2	<b>UNIT 2 - DESIGN AND DEVELOP WEB PAGES</b>		10-0-20
2	<p>2.1 Basic web technologies</p> <ul style="list-style-type: none"> <li>▪ Browser</li> <li>▪ Web -Server</li> <li>▪ Client-Server Model</li> <li>▪ URL</li> <li>▪ SEO techniques</li> <li>▪ Domain names and domain name system.</li> </ul> <p>2.2 Creating Web-pages with HTML5 - Static</p>	<ol style="list-style-type: none"> <li>1. Understand and examine basic web technologies</li> <li>2. Creating static web pages</li> <li>3. Formatting Webpages with cascading style sheets (CSS)</li> <li>4. Creating Dynamic web pages with JavaScript</li> </ol>	

<p>web pages.</p> <ul style="list-style-type: none"> <li>▪ Introduction, Editors</li> <li>▪ Tags, Attributes, Elements, Headings</li> <li>▪ Links, Images, List, Tables, Forms</li> <li>▪ Formatting, Layout, Iframes.</li> </ul> <p>2.3 Formatting web pages with style sheets (CSS3).</p> <ul style="list-style-type: none"> <li>▪ Introduction to CSS</li> <li>▪ Inline CSS, Internal CSS, Classes and IDs</li> <li>▪ div, Color, Floating, Positioning</li> <li>▪ Margins, Padding, Borders</li> <li>▪ Fonts, Aligning Text, Styling Links</li> </ul> <p>2.4 Creating a web page dynamic using JavaScript.</p> <ul style="list-style-type: none"> <li>▪ Dynamic web page and Introduction to JS</li> <li>▪ Basic syntax</li> <li>▪ Functions</li> <li>▪ Events</li> </ul> <p>Note: Refer <a href="https://www.w3schools.com">https://www.w3schools.com</a></p> <p>2.6 Creating dashboards in websites.</p> <p><b>2.6 Activity: Personal website design and launch with a free platform or Create a Blogging website.</b></p> <ul style="list-style-type: none"> <li>▪ Online platforms (Learning and executing)</li> <li>▪ <a href="https://www.w3schools.com/">https://www.w3schools.com/</a></li> <li>▪ <a href="https://studio.code.org">https://studio.code.org</a></li> <li>▪ <a href="https://www.khanacademy.org">https://www.khanacademy.org</a></li> </ul> <p><b>Note:</b></p> <p>1) The student must be introduced to website development platforms - <a href="https://www.wordpress.com">wordpress.com</a>.</p> <p>2) The student must be made familiar</p>	<p>5. Creating and launching dashboard based personal website.</p>	
--	--	--



	<p><b>with launching websites.</b></p> <p>Certification available:</p> <ul style="list-style-type: none"> <li>• HTML - W3schools</li> <li>• CSS - W3schools</li> <li>• JavaScript - W3schools</li> </ul>		
3	<b>UNIT 3 -BUSINESS PROCESS AUTOMATION/ERP</b>		03:0:06
3	<p>3.1 Introduction to business process automation.</p> <p>3.2 Organization structure and functions composition-Properties and applications</p> <ul style="list-style-type: none"> <li>▪ Structure</li> <li>▪ Types</li> <li>▪ Functional Units</li> </ul> <p><b>Note: Students should be made familiar with organization, types and components of a big enterprise to make him understand the working of organization keeping him as part of org.</b></p> <p>3.3 Workflows</p> <ul style="list-style-type: none"> <li>▪ Introduction</li> <li>▪ Components</li> <li>▪ Use and use cases</li> </ul> <p><b>Note: Use free and open-source platform to demonstrate and create workflows.</b></p> <p><b>Example:</b></p> <p><a href="https://airflow.apache.org/">https://airflow.apache.org/</a></p> <p><a href="https://taverna.incubator.apache.org/">https://taverna.incubator.apache.org/</a></p> <p><a href="https://trello.com/">https://trello.com/</a></p> <p><a href="https://www.processmaker.com/">https://www.processmaker.com/</a></p> <p>3.4 Enterprise resource planning</p> <ul style="list-style-type: none"> <li>▪ History</li> <li>▪ Evolution</li> <li>▪ Uses of ERP</li> <li>▪ ERP software tools.</li> </ul>	<ol style="list-style-type: none"> <li>1. Identify and examine the needs of business process automation.</li> <li>2. Understand Organization structure and functions</li> <li>3. Create and use workflows</li> <li>4. Use Enterprise resource planning in workplace.</li> </ol>	

	<p><b>Note: The student should be introduced into Enterprise resource planning software tools to understand importance of ERP.</b></p> <p><b>Examples:</b></p> <ul style="list-style-type: none"> <li>▪ <a href="https://erpnext.com/">https://erpnext.com/</a></li> <li>▪ <a href="http://www.bitrix24.com">www.bitrix24.com</a></li> <li>▪ <a href="https://www.odoo.com/">https://www.odoo.com/</a></li> </ul> <p><b>3.5 Activity:</b></p> <ul style="list-style-type: none"> <li>▪ <b>Project plan for summer internship - use open source ERP Software</b></li> <li>▪ <b>Identify different components of nearby organization with recourse plan and workflow design.</b></li> <li>▪ <b>Identify types of ERP software available with their market share.</b></li> </ul>		
4	<b>UNIT 4 - INTRODUCTION TO CLOUD AND IOT CONCEPTS</b>		04-0-8
	<p>4.1 Fundamentals of cloud</p> <p>4.2 Cloud service models</p> <ul style="list-style-type: none"> <li>▪ IaaS (Infrastructure-as-a-Service)</li> <li>▪ PaaS (Platform-as-a-Service)</li> <li>▪ SaaS (Software-as-a-Service)</li> </ul> <p>4.3 Cloud deployment types</p> <ul style="list-style-type: none"> <li>▪ Public,</li> <li>▪ Private,</li> <li>▪ Hybrid</li> <li>▪ Community Cloud</li> </ul> <p>4.4 Cloud services:</p> <ul style="list-style-type: none"> <li>▪ Google Drive - file storage and synchronization service developed by Google;</li> <li>▪ Google docs- bring your documents to life with smart editing and styling tools to help you easily format text and paragraphs;</li> <li>▪ Google Co-lab (Usage of Jupyter Notebook): <i>Colab</i> notebooks allow you to combine</li> </ul>	<ol style="list-style-type: none"> <li>1. Understand Cloud concepts</li> <li>2. Identify and use Cloud services</li> <li>3. UnderstandIoT concepts</li> <li>4. Identify IoT applications</li> </ol>	

	<p>executable code and rich text in a single document, along with images, HTML, LaTeX, and more.</p> <ul style="list-style-type: none"> <li>▪ Google App Engine: Google App Engine is a Platform as a Service and cloud computing platform for developing and hosting web applications in Google-managed data centers. Applications are sandboxed and run across multiple servers.</li> </ul> <p><b>Note: Above cloud services are not compulsory for all branches; teacher can recommend other cloud service based on need of engineering branch.</b></p> <p>4.5 Working of IoT and IoT components (Only brief introduction and demonstration through videos)</p> <p>4.6 Explain concept of Internet of Things with examples</p> <ul style="list-style-type: none"> <li>▪ Smart home</li> <li>▪ Smart city</li> <li>▪ Smart farming</li> </ul> <p><b>Note:</b></p> <p>a. <b>Teacher can also select specific area of work where Things (autonomous computing devices) could be interconnected over TCP/IP to establish IoT.</b></p> <p>b. <b>The students should be introduced to the IoT environment for further research and study.</b></p> <p><b>Example:</b></p> <ul style="list-style-type: none"> <li>▪ <a href="https://www.raspberrypi.org/">https://www.raspberrypi.org/</a></li> <li>▪ <a href="https://www.arduino.cc/">https://www.arduino.cc/</a></li> </ul>		
--	--	--	--

	<p><b>4.7 Activity:</b>  <b>Create your cloud service account and demonstrate using cloud services.</b>  <b>Identify cloud service provider with respect to service models and deployment types.</b>  <b>Identify areas where Internet of Things could bring positive changes.</b></p>		
5	<b>UNIT 5 - CYBERSECURITY AND SAFETY</b>		<b>4-0-8</b>
	<p>5.1 Introduction to Cyber security and cyber safety.</p> <ul style="list-style-type: none"> <li>▪ Brief awareness on cyber safety measures</li> <li>▪ Identification of basic security issues in mobile phones and personal computers</li> <li>▪ Installation of Antivirus software</li> <li>▪ Firewall concepts</li> <li>▪ Browser settings</li> <li>▪ Importance of privacy and Password policy (Best practices).</li> </ul> <p>5.2 Common threats - Demonstration</p> <ul style="list-style-type: none"> <li>▪ Phishing</li> <li>▪ DoS attack</li> <li>▪ Man in the middle attack</li> <li>▪ Eavesdropping</li> <li>▪ Spamming</li> </ul> <p><b>5.3 Activity</b></p> <ul style="list-style-type: none"> <li>▪ <b>Identification of basic security issues in computers of your college and fixing the same.</b></li> <li>▪ <b>Visit nearby government organization.</b> <ul style="list-style-type: none"> <li>▪ <b>Identify basic cybersecurity issues and fixing the same</b></li> <li>▪ <b>Demonstrate the importance of cybersecurity, password policy, and cyber safety.</b></li> </ul> </li> </ul>	<ol style="list-style-type: none"> <li>1. Identify need for Cyber security and cyber safety</li> <li>2. Identify basic security issues in mobile phones and personal computers</li> <li>3. Examine Importance of privacy, Password policy</li> <li>4. Implement best practices of cyber safety and security in work place</li> </ol>	

**10. SUGGESTED PRACTICAL SKILL EXERCISES****TABLE-I**

Sl. No.	Practical Out Comes/Practical exercises	Unit No.	PO	CO
1	Write an algorithm for programmable problems Example for Reference: <ul style="list-style-type: none"> <li>• Add/subtract two numbers</li> <li>• Find the largest/smallest of 3 numbers</li> <li>• Calculate and print sum of 'N' numbers</li> </ul>	1	1,4,7	1
2	Design a flowchart for programmable problems Example for Reference: Add/subtract two numbers Find the largest/smallest of 3 numbers Calculate and print sum of 'N' numbers	1	1,4,7	1
3	Design and create simple game using MIT-scratch/Code.org	1	1,4,7	1
4	Design and create simple android application (MIT App Inventor)	1	1,4,7	1
5	Design and create webpage for displaying your poem (Title, header, paragraph, formatting tags)	2	1,4,7	2
6	Design and create webpage for your wish list (What you want to do). Also list challenges and opportunities along with images to present your dreams (List ordered and unordered, Image, table)	2	1,4,7	2
7	Design and create webpage using HTML and CSS about an awesome animal (Use necessary CSS tags)	2	1,4,7	2
8	Design and create web page for a travel book/recipe book with more than 3 pages, table to list places/recipes (iframe, hyperlink)	2	1,4,7	2
9	Design and create web page with JavaScript to design a simple calculator to perform the following operations: sum, product, difference and quotient	2	1,4,7	2
10	Design and create a personal webpage with dashboard	2	1,4,7	2
11	Design and create web page about advantages of business process automation with respect to your branch of engineering	2,3	1,4,7	2,3

12	Create a workflow for education loan approval in bank/diploma admission process (Use any tool)	3	1,4,7	3
13	Demonstrate ERP with ERPNext Demo for manufacturing, retail and service sector (Use any other ERP tools)	3	1,4,7	3
14	Create user account and demonstrate use of Google drive, Google docs, Google Co-lab (Usage of Jupyter Notebook)	4	1,4,7	4
15	1.1 Demonstrate Internet of Things using with examples a. Smart home b. Smart city c. Smart farming Note: Teacher can also select specific area of work where Things (autonomous computing devices) could be interconnected over TCP/IP to establish IoT.	4	1,4,7	4
16	Installation of Antivirus software	5	1,4,7	5
17	Demonstration and hands on browser settings	5	1,4,7	5
18	Demonstration and hands on privacy settings and password policy	5	1,4,7	5
19	Demonstration of common security threats (using videos) a. Phishing b. DoS attack c. Man in the middle attack d. Spamming e. Virus	5	1,4,7	5

The suggested practical activities (TABLE-I) in this section are demonstrated for the attainment of the competency. These practical activities can also be used for the student assessment in portfolio mode for awarding CIE marks. **The lecturer can enhance the competency level of the students by sketching more practical exercises.**

**NOTES:**

1. It is compulsory to prepare log book/record of exercises. It is also required to get each exercise recorded in logbook, checked and duly dated signed by the teacher
2. Student activities are compulsory and are also required to be performed and noted in logbook.
3. Student activity is compulsory and part of skill assessment. The activity enable student to explore the course, help student to demonstrate creativity & critical thinking.
4. Student activity report is compulsory part to be submitted at the time of practical ESE
5. Term work report is compulsory part to be submitted at the time of practical ESE.

6. Student activity and student activity reports must be uploaded to Learning management system.
7. For CIE, students are to be assessed for Skills/competencies achieved.

### 11. MAPPING OF CO WITH PO

COURSE	CO'S	PROGRAMME OUTCOMES (PO'S)						
		1	2	3	4	5	6	7
IT SKILLS	CO1	3	0	0	3	0	0	3
	CO2	3	0	0	3	0	0	3
	CO3	3	0	0	3	0	0	0
	CO4	3	0	0	3	0	0	3
	CO5	3	0	0	3	0	0	0
<b>Level 3- Highly Mapped, Level 2-Moderately Mapped, Level 1-Low Mapped, Level 0- Not Mapped</b>								

### 12 SUGGESTED LEARNING RESOURCES

BOOKS	
1	The Art of Programming Through Flowcharts & Algorithms, A. B. Chaudhuri, Firewall Media publication
2	HTML5 Black Book, by Publishing company Limited. Kogent Learning Solutions Inc.
3	“World Wide Web design with HTML”, Xavier, Tata McGraw-Hill
4	Internet of Things – A Hands on Approach, By ArshdeepBahga and Vijay Madiseti Universities Press, ISBN: 9788173719547
URL'S	
1	<a href="https://scratch.mit.edu">https://scratch.mit.edu</a>
2	<a href="https://studio.code.org">https://studio.code.org</a>
3	<a href="http://ai2.appinventor.mit.edu">http://ai2.appinventor.mit.edu</a>
4	<a href="https://www.w3schools.com">https://www.w3schools.com</a>
5	<a href="https://www.tutorialspoint.com/javascript/index.htm">https://www.tutorialspoint.com/javascript/index.htm</a>
6	<a href="https://www.geeksforgeeks.org/html-tutorials/">https://www.geeksforgeeks.org/html-tutorials/</a>
7	Android <a href="https://developer.android.com">https://developer.android.com</a>
8	<a href="https://www.khanacademy.org">https://www.khanacademy.org</a>
9	Tools for Web Development a. <a href="https://www.wix.com">https://www.wix.com</a>

b. <a href="https://atom.io/">https://atom.io/</a>
c. <a href="https://www.openelement.com/">https://www.openelement.com/</a>
d. <a href="https://www.layoutit.com">https://www.layoutit.com</a>

### 13. SUGGESTED LIST OF PROPOSED STUDENTS ACTIVITY

**Note:** Refer activities mentioned in DETAILS OF COURSE CONTENT table

### 14. COURSE ASSESSMENT AND EVALUATION CHART

SL.N O	ASSESSMENT	DURATIO N (in minutes)	MAX MARKS	CONVERSION
1	CIE Assessment 1 ( Written Test -1 TH) - At the end of 3 <sup>d</sup> week	60	20	Average of two written tests 20
2	CIE Assessment 2 (Written Test -2 TH) - At the end of 13 week	60	20	
3	CIE Assessment 3 (Skill Test) - At the end of 5 week	3 hrs	20	Average of three skill test 20
4	CIE Assessment 4 (Skill Test) - At the end of 7 week	3 hrs	20	
5	CIE Assessment 5 (Skill Test) - At the end of 9 week	3 hrs	20	
6	CIE Assessment 6 (Student activity)- At the end of 11 week	-	20	20
7	<b>Total Continuous Internal Evaluation (CIE) Assessment</b>			<b>60</b>
8	Semester End Examination (SEE) Assessment (Practical Test)	3 hrs	100	40
<b>TOAL MARKS</b>				<b>100</b>
Note: CIE written test is conducted for 20 marks (Two sections). Each section shall have two full questions of same CL, CO. Student shall answer one full question from each section.				



**15. RUBRICS FOR ACTIVITY**

<b>RUBRICS FOR ACTIVITY (Example Only)</b>						
<b>Appropriate rubrics shall be developed by the concerned faculty</b>						
<b>Dimension</b>	<b>Poor</b>	<b>Below Average</b>	<b>Average</b>	<b>Good</b>	<b>Exemplary</b>	<b>Student Score</b>
	<b>4</b>	<b>8</b>	<b>12</b>	<b>16</b>	<b>20</b>	
<b>Concept</b>	Does not collect any information relating to the concept	Collects very limited information; some relate to the concept	Collect much information; but very limited relate to the concept	Collects some basic information; most refer to the concept	Collects a great deal of information; all refer to the concept	8
<b>Design</b>	Design is not acceptable/very poorly structured	Design is poor and not well structured.	Design Followed layout samples and well structured	Design & convey both content and context	Design considered all aspect of concept, concept and presentation (UI)	6
<b>Creativity</b>	Very little creativity in design/implementation	Creativity in concept or design or implementation	Creativity in concept /design/implementation	Creativity in concept /design/implementation which complements each other	Creative concept, content, presentation and implementation	8
<b>Implementation</b>	Poorly implemented	Partially implemented	Implemented on time with results (content)	Product convey both content and context	Product is creative with easy-to-use UI, structure	8
<b>Average / Total Marks: (8+6+8+8)/4</b>						<b>7.5 = 8</b>

**16. RUBRICS for Skill Test Evaluation (Both for CIE & SEE)**

SI No	Parameter to be Observed	Marks Allotted
1	Design-Written Skill Test 1: Algorithm / Flowchart/Visual Design Skill Test 2: Web site visual design Skill Test 3: Work flow or Project plan or cyber security plan or Cloud service Concept	30
2	Implementation Skill Test 1: Android application Skill Test 2: Web site / Web pages Skill Test 3: Create or use cloud service account or Cyber safety and security- Antivirus Installation or browser settings	50
3	Appeal and Presentation	20
<b>Total</b>		<b>100</b>

**17. SYSTEM REQUIREMENTS:**

Sl. No.	Specification	Quantity
1.	Computers with HD Graphics Card	20
2.	Software: GIMP, KRETA, BLENDER, PHOTOSHOP or any other relevant open-source software.	-
3.	Internet Connectivity	-

**Note: Above specification is for a batch of 20 students**

**Government of Karnataka**  
**Department of Collegiate and Technical Education**  
**Board of Technical Examinations, Bangalore**

<b>Course Code</b>	20AU01T	<b>Semester</b>	I
<b>Course Title</b>	<b>ENVIRONMENTAL SUSTAINABILITY</b>	<b>Course Group</b>	Audit
<b>No. of Credits</b>	2	<b>Type of Course</b>	Lecture
<b>Course Category</b>	AU	<b>Total Contact Hours</b>	2Hrs Per Week
			26Hrs Per Semester
<b>Prerequisites</b>	Basic Environmental Science	<b>Teaching Scheme</b>	(L: T:P) = 2:0:0
<b>CIE Marks</b>	50	<b>SEE Marks</b>	No

**COURSE OBJECTIVES:**

*Technicians working in industries or elsewhere essentially require the knowledge of environmental science so as to enable them to work and produce most efficient, economical and eco-friendly finished products.*

1. Solve various engineering problems applying ecosystem to produce eco - friendly products.
2. Use relevant air and noise control methods to solve domestic and industrial problems.
3. Use relevant water and soil control methods to solve domestic and industrial problems.
4. To recognize relevant energy sources required for domestic and industrial applications.
5. Solve local solid and e-waste problems.

**COURSE OUTCOMES:**

*At the end of the course student will be able to know:*

<b>C01</b>	Importance of ecosystem and terminology.
<b>C02</b>	The extent of air pollution, effects, control measures and acts.
<b>C03</b>	The extent of noise pollution, effects, control measures and acts.
<b>C04</b>	The water and soil pollution, effects, control measures and acts
<b>C05</b>	Different renewable energy resources and efficient process of harvesting.
<b>C06</b>	Solid Waste Management and Environmental acts.

**COURSE CONTENT:**

<i>Marks: 15</i>	<b>Unit-1 Ecosystem</b>	<i>Allotted Hrs: 03</i>
Structure of ecosystem, Biotic & Abiotic components, Aquatic (Lentic and Lotic) and terrestrial ecosystem. Global warming - Causes, effects, Green House Effect, Ozone depletion.		
<i>Marks: 20</i>	<b>Unit-2 Air Pollution</b>	<i>Allotted Hrs: 03</i>
Air pollution, Natural and manmade sources of air pollution, Effects of air pollution. Air Pollutants and Types. Control of air pollutants by Cyclone separator and Electrostatic Precipitator, Air (prevention and control of pollution) act 1981		
<i>Marks: 10</i>	<b>Unit-3 Noise Pollution:</b>	<i>Allotted Hrs: 02</i>
Noise pollution: sources of pollution, measurement of pollution level, Effects and Control of Noise pollution, Noise pollution (Regulation and Control) Rules, 2000		
<i>Marks: 20</i>	<b>Unit- 4 Water and Soil Pollution:</b>	<i>Allotted Hrs: 06</i>
Water pollution and Sources of water pollution, Types of water pollutants, Characteristics of water pollutants, control measures of water pollution. Definition and list unit operations in water and Wastewater Treatment process, Water (prevention and control of pollution) act 1974, Water conservation – Importance of Rainwater Harvesting. Soil pollution, Causes, Effects and Preventive measures of Soil Pollution due to Excessive use of Fertilizers, Pesticides and Insecticides		
<i>Marks: 20</i>	<b>Unit-5 Renewable sources of Energy</b>	<i>Allotted Hrs: 07</i>
<i>Solar Energy:</i> Basics of Solar energy. Definition and advantages of advanced solar collectors. Solar water heater and Solar stills and their uses. <i>Biomass:</i> Overview of biomass as energy source. Thermal characteristics of biomass as fuel. <i>Wind energy:</i> Current status and future prospects of wind energy. Wind energy in India. Need of new Energy sources, Different type's new energy sources. Environmental benefits of New Energy Sources-Hydrogen energy, Ocean energy resources, Tidal energy conversion.		
<i>Marks: 15</i>	<b>Unit-6 Solid Waste Management and Environmental Acts</b>	<i>Allotted Hrs: 05</i>
Solid waste generation, Sources and characteristics of Municipal solid waste, Solid Waste Management rules 2016- 3R in SWM. E- Waste generation, Sources and characteristics, E waste management rules 2016 Plastic Waste generation, Sources and characteristics, Recycled plastic rules 2016 Importance of Environment (protection) act 1986 Occupational health and safety measures.		

<b>Unit No &amp; Name</b>	<b>Detailed Course Content</b>	<b>CO</b>	<b>PO</b>	<b>Contact Hrs</b>
1. Ecosystem	Structure of ecosystem, Biotic & Abiotic components, Aquatic (Lentic and Lotic) and terrestrial ecosystem.	C01	1,5,7	1
	Global warming - Causes, effects.	C01	1,5,7	2
	Green House Effect, Ozone depletion - Causes, effects	C01	1,5,7	3
2. Air and Pollution	Air pollution, Natural sources of air pollution, Man Made sources of air pollution	C02	1,5,7	4
	Air pollutants and Types, Effects of Particulate Pollutants and control by Cyclone separator	C02	1,5,7	5
	Effects of Particulate Pollutants and control by Electrostatic Precipitator, Air (prevention and control of pollution) act 1981.	C02	1,5,7	6
3. Noise Pollution	Noise pollution: sources of pollution, Measurement of Noise pollution level.	C03	1,5,7	7
	Effects and Control of Noise pollution. Noise pollution (Regulation and Control) Rules, 2000	C03	1,5,7	8
4. Water and Soil Pollution:	Sources of water pollution. Types of water pollutants, Characteristics of water pollutants.	C04	1,5,7	9
	Control measures of water pollution.	C04	1,5,7	10
	Definition and list unit operations in water and Wastewater Treatment process, Water (prevention and control of pollution) act 1974.	C04	1,5,7	11
	Water conservation – Importance of Rainwater Harvesting	C04	1,5,7	12
	Soil pollution, Causes and Effects due to Fertilizers, Pesticides and Insecticides	C04	1,5,7	13
	Preventive measures of Soil Pollution due to Excessive use of Fertilizers, Pesticides and Insecticides.	C04	1,5,7	14
5. Renewable sources of Energy	Solar Energy: Basics of Solar energy. Solar collectors and advantages of Advanced solar collectors.	C05	1,5,7	15
	Solar water heater, Solar stills and their uses.	C05	1,5,7	16
	Biomass: Overview of biomass as energy source. Thermal characteristics of biomass as fuel.			17
	Wind energy: Current status and future prospects of wind energy. Wind energy in India.	C05	1,5,7	18
	Need of new Energy sources, Different type's new energy sources. Environmental benefits of New Energy Sources-Hydrogen energy	C05	1,5,7	19
	Environmental benefits of New Energy Sources- Ocean energy resources	C05	1,5,7	20
	Environmental benefits of New Energy Sources-Tidal energy conversion.	C05	1,5,7	21
6. Solid Waste Management and Environmental Acts	Solid waste generation, Sources, Characteristics of solid waste Solid Waste Management rules 2016	C06	1,5,7	22
	E- Waste generation Sources and characteristics, E waste management rules 2016	C06	1,5,7	23
	Plastic Waste generation Sources and characteristics, Plastic Waste Sources and characteristics	C06	1,5,7	24

	Recycled plastic rules 2016, Importance of Environment (protection) act 1986,	CO6	1,5,7	25
	Occupational health and safety measures.	CO6	1,5,7	26
			<b>Total</b>	<b>26</b>

### References:

#### (a) Suggested Learning Resources:

##### Books:

1. S.C. Sharma & M.P. Poonia, Environmental Studies, Khanna Publishing House, New Delhi
2. C.N. R. Rao, Understanding Chemistry, Universities Press (India) Pvt. Ltd., 2011.
3. Arceivala, Soli Asolekar, Shyam, Wastewater Treatment for Pollution Control and Reuse, Mc-Graw Hill Education India Pvt. Ltd., New York, 2007, ISBN:978-07-062099.
4. Nazaroff, William, Cohen, Lisa, Environmental Engineering Science, Willy, New York, 2000, ISBN 10: 0471144940.
5. O.P. Gupta, Elements of Environmental Pollution Control, Khanna Publishing House, New Delhi
6. Rao, C. S., Environmental Pollution Control and Engineering, New Age International Publication, 2007, ISBN: 81-224-1835-X.
1. Rao, M. N. Rao, H.V.N, Air Pollution, Tata Mc-Graw Hill Publication, New Delhi, 1988, ISBN: 0-07-451871-8.
2. Frank Kreith, Jan F Kreider, Principles of Solar Engineering, McGraw-Hill, New York ; 1978, ISBN: 9780070354760.
7. Aldo Vieira, Da Rosa, Fundamentals of renewable energy processes, Academic Press Oxford, UK; 2013. ISBN: 9780123978257.
3. Patvardhan, A.D, Industrial Solid Waste, Teri Press, New Delhi, 2013, ISBN:978-81-7993-502-6
4. Metcalf & Eddy, Wastewater Engineering, Mc-Graw Hill, New York, 2013, ISBN: 077441206.
5. Keshav Kant, Air Pollution & Control, Khanna Publishing House, New Delhi (Edition 2018)

#### (b) Open source software and website address:

- 1) [www.eco-prayer.org](http://www.eco-prayer.org)
- 2) [www.teriin.org](http://www.teriin.org)
- 3) [www.cpcp.nic.in](http://www.cpcp.nic.in)
- 4) [www.cpcp.gov.in](http://www.cpcp.gov.in)
- 5) [www.indiaenvironmentportal.org.in](http://www.indiaenvironmentportal.org.in)
- 6) [www.whatis.techtarget.com](http://www.whatis.techtarget.com)
- 7) [www.sustainabledevelopment.un.org](http://www.sustainabledevelopment.un.org)
- 8) [www.conserve-energy-future.com](http://www.conserve-energy-future.com)

#### Teachers should use the following strategies to achieve the various outcomes of the course.

- Different methods of teaching and media to be used to attain classroom attention.
- Massive open online courses (MOOCs) may be used to teach various topics/subtopics.
- 15-20% of the topics which are relatively simpler or descriptive in nature should be given to the students for self-learning and assess the development of competency through classroom presentations.
- Micro-projects may be given to group of students for hand-on experiences

- Encouraging students to visit sites such as Railway station and research establishment around the institution.

### Mapping of Course Outcomes with Programme Outcomes

CO	Course Outcome	PO Mapped	Cognitive Level R/U/A	Theory Sessions In Hrs	Allotted marks for CIE on cognitive levels		TOTAL
					R	U	
C01	Importance Of ecosystem and terminology	1,5,7	R, U	03	02	02	04
C02	The extent of air pollution, effects, control measures and acts.	1,5,7	R, U	03	03	02	05
C03	The extent of noise pollution, effects, control measures and acts.	1,5,7	R, U	02	03	02	05
C04	The water and soil pollution, effects, control measures and acts	1,5,7	R, U	06	03	02	05
C05	Different renewable energy resources and efficient process of harvesting.	1,5,7	R, U	07	03	02	05
C06	Solid Waste Management and Environmental acts.	1,5,7	R, U	05	02	04	06
<b>Total Hours of instruction</b>				<b>26</b>	<b>30</b>		

R-Remember; U-Understanding.

### Level of Mapping PO's with CO's

Course	CO's	Programme Outcomes (PO's)						
		1	2	3	4	5	6	7
<b>Environmental Science</b>	C01	3	0	0	0	2	0	1
	C02	3	0	0	0	2	0	1
	C03	3	0	0	0	2	0	1
	C04	3	0	0	0	2	0	1
	C05	3	0	0	0	2	0	1
	C06	3	0	0	0	2	0	1

**Level 3- Highly Mapped, Level 2-Moderately Mapped, Level 1-Low Mapped, Level 0- Not Mapped**

Method is to relate the level of PO with the number of hours devoted to the CO s which maps the given PO.  
 If  $\geq 50\%$  of classroom sessions related to the CO are addressing a particular PO, it is considered that PO is mapped at Level 3  
 If 30 to 50% of classroom sessions related to the CO are addressing a particular PO, it is considered that PO is mapped at Level 2  
 If 5 to 30% of classroom sessions related to the CO are addressing a particular PO, it is considered that PO is mapped at Level 1  
 If < 5% of classroom sessions related to the CO are addressing a particular PO, it is considered that PO is considered not mapped i.e. Level 0

### Course Assessment and Evaluation Chart

Sl. No	Assessment	Duration	Max marks	Conversion
1.	CIE Assessment 1 (Written Test -1 - At the end of 3 <sup>d</sup> week	80 minutes	30	Average of three written tests 30
2.	CIE Assessment 2 (Written Test -2) - At the end of 7 week	80 minutes	30	
3.	CIE Assessment 3 (Written Test -3) - At the end of 13 week	80 minutes	30	
4	CIE Assessment 4 (MCQ/Quiz) - At the end of 5 week	60 minutes	20	Average of three 20
5	CIE Assessment 5 (Open book Test) - At the end of 9 week	60 minutes	20	
6	CIE Assessment 6 (Student activity/Assignment)- At the end of 11 week	60 minutes	20	
7.	Total Continuous Internal Evaluation (CIE) Assessment			50
<b>Total Marks</b>				<b>50</b>

**Note:**

1. Average marks of Three CIE shall be rounded off to the next higher digit.
2. Assessment of assignment and student activity is evaluated through appropriate rubrics by the respective course coordinator. The secured mark in each case is rounded off to the next higher digit.

**MANDATORY STUDENT ACTIVITY: EACH STUDENT HAS TO SELECT ANY ONE OF THE LISTED**

1. Students chose one thing to reduce at home each week and write journal entries about their successes and challenges implementing the change. In class, they form groups and create "Do You Know?" posters.
2. Students pretend they are architects and come up with a series of design changes to make their school more environmentally friendly. They then grade their projects according to a rubric.
3. A presentation for Green Team Club members to introduce themselves and the purpose of their club. They explain how to use their new recycling bins, in the classroom and in the cafeteria.
4. Ever wonder what's in your school's waste? This hands-on activity helps students assess their school's waste in order to think of ways to reduce it. The results can be incorporated into the school's recycling plan.
5. How do we measure climate change? What activities contribute to climate change?



6. 6. Start a compost or worm bin. Composting is a hands-on way to learn about important life science concepts such as ecosystems, food webs and biodegradation. Students experience how worms and other decomposers recycle fruits and vegetable scraps into compost. Use the compost in your college garden! Have green team students make up a skit and present details about the new composting program to all classrooms. Have them make signs for the bins (compost, recycle, and landfill), monitor the waste collection at lunchtime, cart the food waste to the compost, and decide how and where the compost will be used.
7. Paint posters and decorate bulletin boards or the doors to the cafeteria with waste-free lunch messages to announce or support a waste-free event, and have students vote for their favorite poster.
8. Conduct a classroom audit to identify waste and look for ideas to reduce and reuse. Empower the student to set goals, search for solutions and review progress.
9. Go on a field trip. Visit your local landfill, recycling centre, or a nearby composting facility where the students can see first-hand what is happening to waste and learn about the lifecycle of waste and its effect on the environment.
10. Home energy audit: Have students make a list of all the appliances and light bulbs in their house. How much energy does their house use if all the lights are on for 4 hours per day? If their appliances are on for 2 hours per day? How much energy could they save if they switched to energy-efficient appliances or lightbulbs?
11. Use recycled material in art projects: Recycled materials can make beautiful art projects such as jewelry, planters, and bird houses. Incorporating materials that would otherwise be thrown away into art projects can show your students how to find new uses for these items.
12. Life cycle : One way to show students what happens when you put something in the trash versus recycling or reusing the object is to do a life cycle analysis. This is a flow chart that shows the environmental impacts of an object, from extracting the raw materials to decomposition and everything in between. When something is put in the trash instead of being reused or recycled, the life cycle assessment will show a bigger environmental impact. When something is reused or recycled, the environmental impact is less because raw materials don't need to be extracted to create something new.

**Model Question Paper  
I A Test (CIE)**

<b>Programme</b>	:		<b>Semester: I</b>			
<b>Course</b>	:		<b>Max Marks : 30</b>			
<b>Course Code</b>	:		<b>Duration : 1 Hr 20 minutes</b>			
<b>Name of the course coordinator:</b>			<b>Test : I/II/III</b>			
Note: Answer one full question from each section. One full question carries 10 marks.						
<b>Qn.No</b>	<b>Question</b>	<b>CL</b>	<b>CO</b>	<b>PO</b>	<b>Marks</b>	
<b>Section-1</b>						
1.a)						
b)						
c)						
2.a)						
b)						
c)						
<b>Section-2</b>						
3.a)						
b)						
c)						
4.a)						
b)						
c)						
<b>Section-3</b>						
5.a)						
b)						
c)						
6.a)						
b)						
c)						

**Government of Karnataka**  
**Department of Collegiate and Technical Education**  
**Board of Technical Examinations, Bangalore**

<b>Course Code</b>	20PM01T	<b>Semester</b>	II
<b>Course Title</b>	<b>Project Management Skills</b>	<b>Course Group</b>	PM
<b>No. of Credits</b>	4	<b>Type of Course</b>	Activity based study
<b>Course Category</b>	Theory with Activities	<b>Total Contact Hours</b>	6 Hrs Per Week (2Theory +4 hrs of classroom activities)
			78 Hrs Per Semester
<b>Prerequisites</b>	10 <sup>th</sup> Level Mathematics	<b>Teaching Scheme</b>	4 hrs per week classroom sessions dedicated to case studies & activities
<b>CIE Marks</b>	50	<b>SEE Marks</b>	50

## RATIONALE

*Project Management is a confluence of Management principles and Engineering subject area. This course enables* the students to develop conceptualisation of Engineering Management principles and apply the same for their engineering projects, in their domains, example, Software Development project or Construction Project and so on. The course integrates three core areas of Planning, Execution and Auditing of Projects.

## 1. COURSE SKILL SET

*Student will be able to:*

1. Understand what constitutes a project, Plan for the execution of the project by breaking into manageable work units, and Prepare necessary project artifacts
2. Track and control the Project while preparing verifiable records for Project Inspections and Audits
3. Inspect and Audit projects for Milestones or other project completion criteria and other metrics, Defects and remediation, Project learnings
4. Gain knowledge and develop curiosity on latest technology trends in Project management

## 2. COURSE OUT COMES

*At the end of the course, student will be able to*

<b>CO1</b>	Apply the concepts of Project Management to real projects which are expressed in the form of the Project reports or Engineering drawings
<b>CO2</b>	Estimate Project resources needed Time, Material and Effort, and Plan for execution
<b>CO3</b>	Understand, analyse and assess the risks involved in a project and plan for managing them
<b>CO4</b>	Use Project Management Software and processes to track and control Projects
<b>CO5</b>	Conduct inspection of Projects and audit progress and bills
<b>CO6</b>	Understand the Digital Technology trends in Project management and concepts like Smart cities

## 3. SUGGESTED SPECIFICATION TABLE WITH HOURS & MARKS

UNIT NO	UNIT TITLE	TEACHING HOURS (L-T-P)	MARKS DISTRIBUTION(THEORY)			
			R LEVEL	U LEVEL	A LEVEL	TOTAL
1	Introduction	02-00-04	8	8	4	20
2	Project Administration	06-00-12	8	12	20	40
3	Project Lifecycle	04-00-08	8	12	20	40
4	Project Planning, Scheduling and Monitoring	06-00-12	8	12	20	40
5	Project Control, Review and Audit	06-00-12	8	12	20	40
6	Digital Project Management	02-00-04	8	8	4	20
	<b>Total</b>	26-00-52=78	<b>48</b>	<b>64</b>	<b>88</b>	<b>200</b>

**Legends:** R = Remember; U = Understand; A = Apply and above levels (Bloom's revised taxonomy)

## 4. DETAILS OF COURSE CONTENT

*The following topics/subtopics is to be taught and assessed in order to develop Unit Skill sets for achieving CO to attain identified skill sets.*

UNIT NO	Unit skill set (In cognitive domain)	Topics / Subtopics	Hours L-T-P
1 Introduction	Use Basic Science, Maths skills to understand Project management and project planning, execution and control.	Introduction and definition, Features of a Project, Types of Projects, Benefits and Obstacles in Project Management, Project Management Profession, Role of Project manager, Consultants, Project and Operation, Project Management Process, Project Scope	02-00-04
2 Project Administration	Able to develop WBS, PEP and PM processes for Project with given inputs	Project Administration, Project Team, Project Design, Work Breakdown Structure (WBS), Project Execution Plan (PEP), Systems and Procedure Plan, Project Direction, Communication and Co-ordination, Project Success  Case Study I	06-00-12
3 Project Lifecycle	Use project administration and project lifecycle knowledge to Assess and plan for project risk	Project Life Cycle, Phases - Project Planning, Project Execution, Project Closure, Project Risks, Project Cost Risk Analysis, Time and Cost overruns  Case Study 2a	04-00-08
4. Project Planning, Project Scheduling and Project Monitoring and Implementation	Able to develop a detailed project plan given the inputs on manpower, funds availability and time availability	Project Planning Function, Structure, Project Scheduling, Project monitoring and Project evaluation  Case Study 2b	06-00-12
5. Project Control, Review and Audit	Use Project Management lifecycle knowledge to Control project parameters, review and audit project performance	Project Control, Problems of Project Control, Gantt Charts, Milestone Charts, Critical Path Method (CPM), Network Technique in Project Scheduling, Crashing Project Duration through Network, Project Review, Initial Review, Performance Evaluation,	06-00-12

		Abandonment Analysis, Project Audit  Case Study 2c	
6.Digital Project Management	Understand latest trends of digital technologies impacting the domain of project management and application of the same in multiple scenario	Digital Technology trends in Project management, Cloud Technology, IoT, Smart cities, Data and analytics, case studies  Case study 3	02-00-04

**1. MAPPING OF CO WITH PO**

CO	Course Outcome	PO Mapped	UNIT Linked	CL R/U/A	Sessions in Hrs	TOTAL - Marks
<b>CO1</b>	Understand the concepts of Project Management in relation to real projects which are expressed in the form of the Project reports or Engineering drawings  Case Study - I	<b>1, 2, 5, 7</b>	<b>1, 2</b>	<b>R/U/A</b>	<b>06</b>	<b>10</b>
<b>CO2</b>	Estimate Project resources needed Time, Material and Effort, and Plan for execution  Case study 2a	<b>1, 2, 3, 7</b>	<b>2, 3</b>	<b>R/U/A</b>	<b>18</b>	<b>20</b>
<b>CO3</b>	Evaluate the risks involved in a project and Plan for managing them  Case Study - 2a	<b>1,2,3,7</b>	<b>2,3</b>	<b>R/U/A</b>	<b>12</b>	<b>20</b>

<b>CO4</b>	Use Project Management methods with Software and/or processes to track and control Projects  Case Study 2b	<b>1, 4, 6, 7</b>	4	<b>R/U/A</b>	18	20
<b>CO5</b>	Conduct inspection of Projects and audit progress and bills  Case Study 2c	<b>1, 2, 5, 7</b>	5	<b>R/U/A</b>	18	20
<b>CO6</b>	Understand the Digital Technology trends in Project management, and Engineering Industries  Case Study 3	<b>1, 5, 7</b>	6	<b>R/U/A</b>	06	<b>10</b>
					<b>78</b>	<b>100</b>

	CO's	Programme Outcomes s) (PO						
		1	2	3	4	5	6	7
Project Management	CO1	3	3	0	0	2	0	1
	CO2	3	3	3	0	0	0	1
	CO3	3	0	0	3	0	3	1
	CO4	3	0	0	3	0	3	1
	CO5	3	2	0	0	2	0	1
	CO6	3	0	0	0	2	0	2
<b>Level 3- Highly Mapped, Level 2-Moderately Mapped, Level 1-Low Mapped, Level 0-Not Mapped</b>								

### 7. INSTRUCTIONAL STRATEGY

These are sample Strategies, which teacher can use to accelerate the attainment of the various course outcomes

1. Explicit instruction will be provided in intervention classes or by using different differentiation strategies in the main classroom.

2. Lecturer method (L) does not mean only traditional lecture method, but different type of teaching method and media that are employed to develop the outcomes.
3. Observing the way their more proficient peers use prior knowledge to solve current challenges and persevere in problem solving will help struggling students to improve their approach to engaging with rich contextual problems.
4. Topics be introduced always with a reallife example and then answering What, how, why and when.
5. The teacher is able to show different ways to solve the same problem and encourage the students to come up with their own creative ways to solve them.
6. In a perfect world, teacher would always be able to demonstrate how every concept can be applied to the real world - and when that's possible, it helps improve the students' understanding. When a concept cannot be applied in that manner, we can still share how it might be applied within mathematics.

**8. SUGGESTED LEARNING RESOURCES:**

Sl.No.	Author	Title of Books	Publication/Year
<b>1</b>	<b>Dr. Lalitha Balakrishnan &amp; Dr. Gowri Ramachandran</b>	<b>Project Management</b>	<b>Himalaya Publishing, 2019</b>
<b>2</b>	Shailesh Kumar Shivakumar	Complete Guide to Digital Project Management	Apress, 2019
<b>3</b>	Prasanna Chandra	Project planning, analysis, selection, implementation and review	Tata McGraw Hill
<b>4</b>	Gopala Krishnan	Project Management	Mcmillan India Ltd.

**9. COURSE ASSESSMENT AND EVALUATION CHART**

Sl.No	Assessment	Duration	Max marks	Conversion
<b>1</b>	CIE Assessment 1 ( Written Test -1) At the end of 3 <sup>rd</sup> week	80 minutes	30	Average of three written tests  30
<b>2</b>	CIE Assessment 2 (Written Test -2) At the end of 7 <sup>th</sup> week	80 minutes	30	



Sl.No	Assessment	Duration	Max marks	Conversion
3	CIE Assessment 3 (Written Test -3) At the end of 13 <sup>th</sup> week	80 minutes	30	
4	CIE Assessment 4 (Group Assignment -1) At the end of 5 <sup>th</sup> week	60 minutes	20	Average of three 20
5	CIE Assessment 5 (Group Assignment -2 ) At the end of 9 <sup>th</sup> week	60 minutes	20	
6	CIE Assessment 6 (Individual Student activity/Assignment) At the end of 11 <sup>th</sup> week	60 minutes	20	
Total Continuous Internal Evaluation (CIE) Assessment				<b>50</b>
8	Semester End Examination (SEE) Assessment (Written Test)	3 Hrs	100	<b>50</b>
<b>Total Marks</b>				<b>100</b>

**Note:**

- SEE (Semester End Examination) is conducted for 100 Marks theory course for a time duration of 3 Hrs
- Three CIE (written test), each of 30 marks for a time duration of 80 minutes shall be conducted. Also, three CIE (MCQ or Quiz/Group Assignment/Individual student activity or assignment) each of 20 marks for the time duration of 60 minutes shall be conducted. Any fraction at any stage during evaluation will be rounded off to the next higher digit
- Assessment of assignment and student activity is evaluated through appropriate rubrics by the respective course coordinator. The secured mark in each case is rounded off to the next higher digit.

**10 DETAILED COURSE CONTENT**

Unit No And Name	DETAILED COURSE CONTENT	CONTACT HRS	TOTAL
1. Introduction	1.1 Introduction	3	6
	1.2 Meaning of Project		
	1.3 Definition and No Change Mode		
	1.4 Features of a Project		
	1.5 Types of Projects		
	1.6 Benefits of Project Management		
	1.7 Obstacles in Project Management		
	1.8 Project Management A Profession		
	1.9 Project Manager and His Role		
	1.10 Project Consultants		
	1.11 What is Operation?	3	
	1.12 Difference between Project and Operation		
	1.13 What is Process in Project Management and Process Groups?		
	1.14 What is Scope? Difference between Project Group Objectives and		
	1.15 Project Scope		
2. Project Administration	2.1 Essentials of Project Administration	3	18
	2.2 Project Team		
	2.3 Project Design		
	2.4 Work Breakdown Structure (WBS)	6	
	2.5 Project Execution Plan (PEP)		
	2.6 Contracting Plan		
	2.7 Work Packing Plan	3	
	2.8 Organisation Plan		
	2.9 Systems and Procedure Plan		
	2.10 Project Procedure Manual	3	
	2.11 Project Diary		
	2.12 Project Execution System		

	2.13 Project Direction		
	2.14 Communication in a Project	<b>3</b>	
	2.15 Project Co-ordination		
	2.16 Pre-requisites for Successful Project Implementation		
3. Project Lifecycle	3.1 Introduction	6	12
	3.2 Phases of Project Life Cycle		
	3.3 Project Management Life Cycle General		
	3.4 Project Planning		
	3.5 Project Execution		
	3.6 Project Closure		
	3.7 Project Risks	3	
	3.8 Types of Risks: Illustrations		
	3.9 Risk Assessment Techniques with Illustrations		
	3.10 Project Cost Risk Analysis	3	
	3.11 Estimating Time and Cost Overrun Risks		
	3.12 Organisation/Procedural/Systemic Reasons for Project Cost Overruns		
	3.13 Time Overruns		
4. Project Planning, Scheduling and Monitoring	4.1 Introduction	6	18
	4.2 Nature of Project Planning		
	4.3 Need for Project Planning		
	4.4 Functions of Project Planning		
	4.5 Steps in Project Planning		
	4.6 Project Planning Structure		
	4.7 Project Objectives and Policies		
	4.8 Tools of Project Planning		
	4.9 Project Scheduling	6	
	4.10 Time Monitoring Efforts		
	4.11 Bounding Schedules		
	4.12 Scheduling to Match Availability of Manpower		

	4.13 Scheduling to Match Release of Funds		
	4.14 Problems in Scheduling Real-life Projects		
	4.15 Introduction	<b>3</b>	
	4.16 Situation Analysis and Problem Definition		
	4.17 Setting Goals and Objectives		
	4.18 Generating Structures and Strategies		
	4.19 Implementation		
	4.20 What is Project Evaluation?	<b>3</b>	
	4.21 Why is Project Evaluation Important?		
	4.22 What are the Challenges in Monitoring and Evaluation?		
5. Project Control, Review and Audit	5.1 Introduction	<b>6</b>	<b>18</b>
	5.2 Projected Control Purposes		
	5.3 Problems of Project Control		
	5.4 Gantt Charts		
	5.5 Milestone Charts		
	5.6 Critical Path Method (CPM)	<b>6</b>	
	5.7 Construction of a Network		
	5.8 Network Technique in Project Scheduling		
	5.9 Crashing Project Duration through Network		
	5.10 Project Review	<b>3</b>	
	5.11 Initial Review		
	5.12 Post Audit		
	5.13 Performance Evaluation		
	5.14 Abandonment Analysis		
	5.15 Objectives of Project Audit	<b>3</b>	
	5.16 Functions of Project Auditor		
	5.17 Project Audit Programme		
	5.18 Difficulties in Establishing Audit Purpose and Scope		

6. Digital Project Management	6.1 Digital Technology trends in Project management	1	6
	6.2 Cloud Technology, IoT, AR and VR applications in Project management, Smart Cities	1	
	6.3 Data Science and Analytics in Project Management	1	
	6.4 Case Studies	3	

### Case Studies:

**Please note:** The Tutors can either use the following Case studies and activities or Design on their own, with the overall Learning Outcomes being met.

#### Case Study I: Residential House – Project Execution Plan

1. Dr. Sunil Kulkarni wants to build a house on his 9000 square feet (90x100) vacant plot in Bengaluru. His requirements were given below.
  - i) He lives with his wife, parents and two college going children.
  - ii) He likes open space around his house and likes to do gardening during free time
  - iii) His wife teaches Yoga and about 30 middle aged and old people attend the daily sessions.
  - iv) He has a budget limitation of INR 230,00,000 for this project and wants to present to his wife on their 20<sup>th</sup> wedding anniversary which is 18 months away.
  - v) His parents can not climb stairs and hence prefer a ground floor room
  - vi) All the rooms should have attached bathrooms

How-ever the Civil contractor who took the work, overshoot the time and money available and hence Dr Sunil was unhappy with the Architect firm who recommended the Contractor.

Task:

- Split the class into groups of three
- Ask them to prepare 2D drawings with Plan, Elevation, Sections and perspectives.

- Prepare the detailed WBS, a Project execution plan and Project communication plan for contractors
- Estimate the quantities
- Discuss on the possible reasons for delay and methods with which performance to both time and budget could have been achieved
- Present it in a seminar, with each group getting 5-10 minutes to present their idea.

### Case Study 2a:

The Columbus Hospital proposed in Hubli is a 200 bed speciality private hospital for treatment of Cancer. The hospital will come up on a 12 acre plot between Hubli-Dharwad. A leading construction company has come forward to complete the hospital works from concept to commissioning in 9 months. The promoters are willing to spend a premium to complete the hospital in 9 month time and are not particular about type of construction, ie, RCC, Steel frame etc. The key requirements are as follows:

- i) 200 bed hospital of which 40 are for critical care (ICU), 40 for pre and post Operative care
- ii) 4 Operation Theatres - 2 Major (Minimum 800 SFT each) and 2 minor (minimum 400 sft each)
- iii) One full fledged Diagnostic laboratory (1500 Sft)
- iv) One 24x7 pharmacy (360 Sft min)
- v) Doctors rooms, Nurses enclosures, Change rooms
- vi) Office with billing counters (min 2000 sft) for all administrative staff
- vii) Wheel chair parking bays, Stretcher parking bays in all floors
- viii) One Cafeteria with 50 person capacity
- ix) One conference room with Multimedia equipment (300 sft min)
- x) Parking for ambulances, 4 wheelers, two wheelers
- xi) Reception and enquiry counter
- xii) All amenities should be accessible for disabled persons
- xiii) Incinerator, Waste storage and disposal area
- xiv) Generator and fuel storage area

### Discuss

- i) The various alternative approaches available to complete the hospital.
- ii) Look into National Building Code and BIS standards for arriving at approximate (+/- 10%) super built-up area required, amenities to be planned
- iii) The various phases of the project according to Project lifecycle and durations
- iv) Prepare the detailed WBS, Project Organisation required and Project Dairy template
- v) Prepare a Project Plan with risks involved and the risk management plan.

- vi) Estimate the cost of time overrun if the project is delayed by 114 calendar days due to issues with approvals

**Case Study 2b:**

For case study 2 above, prepare an Implementation Plan using a spreadsheet software.

Discuss

- i) What happens if a pandemic affects the project in its 7<sup>th</sup> Month. How do you mitigate the possible issues in implementation?
- ii) What happens if during the fourth month of projects the client decides to reduce funds for the month by 50% ?

**Case Study 2c:**

For case study 2 above, prepare a Critical Path method Chart (CPM) showing all main activities in the WBS with milestones.

Discuss

- i) What happens if the client decides to complete the ground floor roof 15 days earlier ?
- ii) What happens if the client reduces the inflow of project funds by 50% for the month 4 ?
- iii) Write an Audit report for the project at the end of 6<sup>th</sup> month

**Case Study 3:**

This will be done as a student activity and has two components.

- i) Research on 3D printing in any industry and prepare a three page article
- ii) Study usage of Drones in different Industries and evaluate the Cost benefits of using the same for any one scenario.

**Model Question Paper**

**I A Test (CIE)**

<b>Programme:</b>	<b>Semester: I</b>
<b>Course:</b>	<b>Max Marks: 30</b>
<b>Course Code:</b>	<b>Duration: 1 Hr 20 minutes</b>
<b>Name of the course coordinator:</b>	<b>Test: I/II/III</b>

Note: Answer one full question from each section. One full question carries 10 marks.

Qn.No	Question	CL	CO	PO	Marks
<b>Section-1</b>					
1.a)					
b)					
c)					
2.a)					
b)					
c)					
<b>Section-2</b>					
3.a)					
b)					
c)					
4.a)					
b)					
c)					
<b>Section-3</b>					
5.a)					
b)					
c)					
6.a)					
b)					
c)					



**Model Question Paper  
Semester End Examination**

<b>Programme:</b>	<b>Semester: I</b>
<b>Course:</b>	<b>Max Marks: 100</b>
<b>Course Code:</b>	<b>Duration: 3 Hrs</b>

<b>Instruction to the Candidate:</b> Answer one full question from each section. One full question carries 20 marks.				
<b>Qn.No</b>	<b>Question</b>	<b>CL</b>	<b>CO</b>	<b>Marks</b>
<b>Section-1</b>				
1.a)				
b)				
2.a)				
b)				
<b>Section-2</b>				
3.a)				
b)				
4.a)				
b)				
<b>Section-3</b>				
5.a)				
b)				
6.a)				
b)				
<b>Section-4</b>				
7.a)				
b)				
8.a)				
b)				
<b>Section-5</b>				
9.a)				
b)				
10.a)				
b)				

**Government of Karnataka**  
**Department of Collegiate and Technical Education**  
**Board of Technical Examinations, Bangalore**

<b>Course Code</b>	20SC02P	<b>Semester</b>	I/II
<b>Course Title</b>	<b>STATISTICS AND ANALYTICS</b>	<b>Course Group</b>	Core
<b>No. of Credits</b>	4	<b>Type of Course</b>	Lecture and practice
<b>Course Category</b>	Practice	<b>Total Contact Hours</b>	6 Hrs Per Week
			78 Hrs Per Semester
<b>Prerequisites</b>	10 <sup>TH</sup> LEVEL MATHEMATICS	<b>Teaching Scheme</b>	(L: T:P)-1:0:2
<b>CIE Marks</b>	60	<b>SEE Marks</b>	40

### RATIONALE

Statistics and analytics help the learner to use the proper methods to collect the data, employ the correct analyses, effectively present the results and conduct research, to be able to read and evaluate journal articles, to further develop critical thinking and analytic skills, to act as an informed consumer and to know when you need to hire outside statistical help. The python language is one of the most accessible programming languages available because it has simplified syntax and not complicated, which gives more emphasis on natural language.

### COURSE OUT COMES

At the end of the course, student will be able to

<b>CO1</b>	Understand the tools of data collection, classification and cleaning of data.
<b>CO2</b>	Able to summarize the given statistical data
<b>CO3</b>	Understand the measure of location and dispersion of data.
<b>CO4</b>	Learn the basics of Python programming.

### DETAILS OF COURSE CONTENT

The following topics/subtopics is to be taught and assessed in order to develop Unit Skill Sets for achieving CO to attain identified skill sets.

UNIT NO	Unit skill set (In cognitive domain)	Topics/Subtopics	Hours L-T-P
<b>UNIT-1 STATISTICAL DATA COLLECTION AND TYPES</b>	<ul style="list-style-type: none"> <li>➤ Able to collect statistical data.</li> <li>➤ Able to distinguish the data types.</li> <li>➤ Understands the usage of data collection tools</li> <li>➤ Able to specify problem statement for data collection</li> <li>➤ Able to collect data pointing the root cause of the problem statement.</li> </ul>	a Definition of data and classification (qualitative quantitative discrete and continuous data). b Data collection tools iv) Questionnaires. v) Survey. vi) Interviews. vii) Focus group discussion. 1.3 Data cleaning.	4-0-8
<b>UNIT-2 SUMMARIZATION OF DATA</b>	<ul style="list-style-type: none"> <li>➤ Sketches bar, pie and histograms on Microsoft Excel spread sheet.</li> <li>➤ Sketches frequency curve and frequency polygon for the data set on Microsoft Excel spread sheet.</li> <li>➤ Sketches bar, pie and histograms on Microsoft Excel spread sheet.</li> <li>➤ Sketches frequency curve and frequency polygon for the data set on Microsoft Excel spread sheet.</li> </ul>	a Descriptive statistics viii) Datatabulation(frequency table ix) Relative frequency table. b Grouped data x) Bar graph xi) Pie chart xii) Line graph xiii) Frequency polygon xiv) Frequency curve xv) Relative frequency polygon xvi) Histograms xvii) Box plot xviii) Leaf-stem plot To be done in Microsoft excel.	8-0-16
<b>UNIT-3 MEASURE OF LOCATION AND DISPERSION</b>	<ul style="list-style-type: none"> <li>➤ Able to determine the descriptive statistical variables using Microsoft Excel.</li> </ul>	a Determination of central tendencies Range, Mean, Mode and Median for the data in Microsoft excel. b Determination of absolute	6-0-12

	<ul style="list-style-type: none"> <li>➤ Able to determine the absolute measures of dispersion of the given data set.</li> <li>➤ Explain the symmetry and asymmetry of the distributed data.</li> </ul>	<p>measures of dispersion for data like range quartile deviation, mean deviation, standard deviation and variance in Microsoft Excel.</p> <p>c Skewness and kurtosis graphs in Microsoft excel and interpretations of results.</p>	
<b>UNIT-4 INTRODUCTION TO PYTHON PROGRAMMING</b>	<ul style="list-style-type: none"> <li>➤ Able Install and run the Python interpreter. Create and execute Python programs.</li> <li>➤ Understand the concepts of file I/O.</li> <li>➤ Able to read data from a text file using Python.</li> <li>➤ Learn variable declarations in Python.</li> <li>➤ Learn control structures.</li> <li>➤ Learn loop constructs.</li> </ul>	<p>4.1 Introduction to PYTHON. 4.2 Syntax of PYTHON. 4.3 Comments of PYTHON. 4.4 Data types of PYTHON. 4.5 Variables of PYTHON. 4.6 If-else in PYTHON. 4.6 Loops in PYTHON. 4.7 Arrays and functions in PYTHON.</p>	<p>8-0- 16</p>

<b>SL NO</b>	<b>Practical outcomes/Practical exercises</b>	<b>Unit no</b>	<b>PO</b>	<b>CO</b>	<b>L:T:P</b>
1	Prepare a questionnaire (closed end) containing 25 questions for a specified problem statement: for example experience of an individual in a restaurant.	1	1,2,4,5,7	1	0:0:2
2	Prepare a Google form for a specified problem statement to collect the dataset. (for example questionnaire to conduct online quiz)	1	1,2,4,5,7	1	0:0:2
3	Send out a survey on your problem statement to number of 50 (By Google forms) and collect the data.	1	1,2,4,5,7	1	0:0:2
4	Remove duplicate or irrelevant observations. Remove unwanted observations from the dataset provided, including duplicate observations or irrelevant observations.	1	1,2,4,5,7	1	0:0:2
5	In Microsoft Excel spread sheet draw the frequency distribution table for the given data (data set should contain minimum 50 data).	2	1,2,4,5,7	2	0:0:2
6	In Microsoft Excel spread sheet draw the relative frequency distribution table for the given data (data set should contain minimum 50 data).	2	1,2,4,5,7	2	0:0:2
7	Using Microsoft Excel spread sheet plot bar graph for the data collected from 100 people( for example, conduct a survey on the favorite fruit of a person in your locality(restricting to 5 to 6 fruits). Explain the bar graph with minimum 30 words.	2	1,2,4,5,7	2	0:0:2
8	Using Microsoft Excel spread sheet plot pie chart for the data collected from 50 people( for example, conduct a survey on the smokers with respect to their ages in your locality. Explain the pie chart with minimum 30 words.	2	1,2,4,5,7	2	0:0:2
9	Using Microsoft Excel spread sheet draw a line graph for the given dataset.	2	1,2,4,5,7	2	0:0:2
10	Using Microsoft Excel spread sheet draw frequency polygon and frequency curve for the data collected from 50 people. (For example, marks obtained by the students in your class in 5 subjects in previous examination). Explain your observations from the graph in minimum 30 words.	2	1,2,4,5,7	2	0:0:2
11	Using Microsoft Excel spread sheet construct a box plot for the given dataset. (For example dataset can be the number of passengers in a flat form at different time in a day).	2	1,2,4,5,7	2	0:0:2
12	Using Microsoft Excel spread sheet construct a leaf plot for the given dataset. Explain the graph with minimum 30 words.	2	1,2,4,5,7	2	0:0:2

13	Using Microsoft Excel spread sheet find the Mean, Mode and Median for the data (univariate data) given and also represent them in a Histogram.	3	1,2,4,5,7	2	0:0:2
14	Generate a 50 random data sample (even and odd number dataset) using Microsoft Excel spread sheet and determine the range and Quartiles.	3	1,2,4,5,7	2	0:0:2
15	Collect the current yield of a crop from 50 different persons (problem statement can be changed according to priorities of the tutor) in your locality and determine mean deviation and Quartile deviation in Microsoft excel spread sheet and brief your inference with less than 30 words.	3	1,2,4,5,7	3	0:0:2
16	Collect the data of any 2 livestock population from 50 different houses in your locality (problem statement can be changed according to priorities of the tutor) and determine standard deviation for both the two separately in Microsoft excel spread sheet and brief your inference with less than 30 words.	3	1,2,4,5,7	3	0:0:2
17	Collect the data of two wheeler (with a rider and a pillion) crossing a busy junction in your locality in the peak hours (problem statement can be changed according to priorities of the tutor) and determine the variance of the data in Microsoft excel spread sheet and brief your inference with less than 30 words.	3	1,2,4,5,7	3	0:0:2
18	Using Microsoft Excel spread sheet draw a Skewness graph and kurtosis graph for randomly generated dataset.	3	1,2,4,5,7	3	0:0:2
20	Write a python program to add 2 integers and 2 strings and print the result.	4	1,2,4,5,7	4	0:0:2
21	Write a python program to find the sum of first 10 natural numbers.	4	1,2,4,5,7	4	0:0:2
22	Write a python program to find whether the number is odd or even.	4	1,2,4,5,7	4	0:0:2
23	Write a python program to find the variance and standard deviation for the given data..	4	1,2,4,5,7	4	0:0:2
24	Write a python program to display student marks from the record.	4	1,2,4,5,7	4	0:0:2
25	Write a python program to create a labeled bar graph using matplotlib. pyplot.	4	1,2,4,5,7	4	0:0:2
26	Write a python program to create a labeled pie chart using matplotlib. pyplot.	4	1,2,4,5,7	4	0:0:2
<b>Total Hours</b>					<b>0:0:52=5 2</b>

**MAPPING OF CO WITH PO**

CO	Course Outcome	PO Mapped	Experiment Linked	Cognitive Level R/U/A	Tutorial & Practical Sessions in Hrs.	TOTAL
CO1	Understand the tools of data collection, classification and cleaning of data.	1,2,4,5,7	1-4	A	12	12
CO2	Able to summarize the given statistical data	1,2,4,5,7	5-12	A	33	33
CO3	Understand the measure of location and dispersion of data.	1,2,4,5,7	13-18	A	12	12
CO4	Learn the basics of Python programming.	1,2,4,5,7	19-26	A	21	21
					<b>78</b>	<b>78</b>

Course	CO's	Programme Outcomes (PO's)						
		1	2	3	4	5	6	7
Statistics & Analytics	CO1	3	3	0	3	3	0	3
	CO2	3	3	0	3	3	0	3
	CO3	3	3	0	3	3	0	3
	CO4	3	3	0	3	3	0	3
<b>Level 3- Highly Mapped, Level 2-Moderately Mapped, Level 1-Low Mapped, Level 0- Not Mapped</b>								

**SUGGESTED LEARNING RESOURCES:**

1. Statistical Analysis with Excel For Dummies (For Dummies Series) Paperback Import, 9 April 2013 by [Joseph Schmuller](#) (Author)
2. <https://www.brianheinold.net/python/A Practical Introduction to Python ProgrammingHeinold.pdf>
3. [http://www.bikeprof.com/uploads/9/0/6/5/9065192/excel\\_stats\\_handout\\_npl.pdf](http://www.bikeprof.com/uploads/9/0/6/5/9065192/excel_stats_handout_npl.pdf)
4. <https://adminfinance.umw.edu/tess/files/2013/06/Excel-Manual1.pdf>
5. <https://www.brianheinold.net/python/A Practical Introduction to Python ProgrammingHeinold.pdf>
6. Introduction to Python programming for beginners by Vivian Baily Kindle edition.
7. PYTHON PROGRAMMING: Python programming: the ultimate guide from a beginner to expert by Clive Campbell.
8. Open source for python: <https://hub.gke2.mybinder.org/user/jupyterlab-jupyterlab-demo-zfkdwy4y/lab>

**SUGGESTED LIST OF STUDENT ACTIVITY**

**Note: The following activities or similar activities for assessing CIE (IA) for 10 marks (Any one)**

1	<p>Describe the data collection activity itself (interviews, surveys, library research, etc.) AND why this specific form of data collection was chosen. Be sure to explain why you think this kind of data will help you in your design process. Also be sure to provide details about the activity: how many interviews, how long they took, where they took place, how many questions asked in a survey, how many respondents, etc.</p> <p>Present the results of your data collection. You do not have to have completely analyzed all your data, but do make sure you present the results of your research. If you did a survey, please attach a copy of the survey as an appendix; if you did interviews, please attach a copy of the interview questions.</p> <p>Discuss any preliminary analysis of your data. What have you learned thus far from the data should be discussed from an analytical perspective (rather than a data dump). For example, if you surveyed people about their use of the local bus system, and 90% of your respondents said they take the bus when it is raining, and 60% of your respondents said they usually wait more than 10 minutes for a bus, think about what this teaches you rather than just the information itself. In this instance, you can see that people are generally waiting for several minutes in the rain for a bus, so a covered bus stop might be a good idea. Keep in mind that your findings from data should lead directly to the conclusions you make about your design recommendations. This is the time to begin thinking very specifically about your research in those terms. This is also an opportunity to think about your definition of “better” and how it applies to your design goals and your choice of research activities (for example, if you are choosing to make something better by making it cheaper, maybe you are interviewing people to see how much loss of functionality or decrease in features for a technology they are willing to tolerate).</p>
2	<p><a href="https://ils.unc.edu/courses/2013_spring/inls541_001/Assignments.html#Assignment_9">https://ils.unc.edu/courses/2013_spring/inls541_001/Assignments.html#Assignment_9</a></p>



	DOWNLOAD a dataset from the above link and use data visualization tools to analyze it.
3	Acquire the dataset from <a href="https://www.kaggle.com/datasets">https://www.kaggle.com/datasets</a> (For example acquire the data of IPL ball by ball scores and find the standard deviation and variance of score of a batsmen)and clean the data for the root cause of the problem statement and summarize the date and explain the inference.

### COURSE ASSESSMENT AND EVALUATION CHART

Method	What		To whom	When/Where (Frequency in the course)	Max Marks	Evidence collected	Course outcomes
<b>DIRECT ASSESSMENT</b>	CIE (Continuous Internal Evaluation)	Models	Students	Two IA Tests (Written)	20	Blue Book	1,2,3.
				Three Skill tests	20	Model	1,2,3
				Student Activity	20	Model/Report	
				<b>TOTAL</b>	60		
	SEE (Semester End Examination)	End Exam		End of the course	100	Models	1,2,3
<b>INDIRECT ASSESSMENT</b>	Student Feedback on course		Students	Middle of the course		Feedback forms	1,2,3, Delivery of course
	End of Course Survey			End of the course		Questionnaires	1,2,3 Effectiveness of Demonstrations & Assessment Methods

Sl.No	Assessment	Duration	Max marks	Conversion
1	CIE Assessment 1 (Written Test -1-theory) - At the end of <b>3<sup>rd</sup> week</b>	60 minutes	20	Average of two written tests 20
2	CIE Assessment 2 (Written Test -2-theory) - At the end of <b>13<sup>th</sup> week</b>	60 minutes	20	
3	CIE Assessment 3 (Skill test) - At the end of <b>5<sup>th</sup> week</b>	3 Hrs	20	Average of three skill tests 20
4	CIE Assessment 4 (Skill test) - At the end of <b>7<sup>th</sup> week</b>	3 Hrs	20	
5	CIE Assessment 5 (Skill test) - At the end of <b>9<sup>th</sup> week</b>	3Hrs	20	
6	CIE Assessment 6 (Student activity) - At the end of <b>11<sup>th</sup> week</b>	-	20	20
7	Total Continuous Internal Evaluation (CIE) Assessment			60
8	Semester End Examination (SEE) Assessment (Practical Test)	3Hrs	100	40
<b>Total Marks</b>				<b>100</b>

**Note:**

1. CIE written test is conducted for 20 marks (Two sections). Each section shall have two full questions of same CL, CO. Student shall answer one full question (10 marks) from each section.
2. CIE Skill test is conducted for 100 marks (3 Hours duration) as per scheme of evaluation and the obtained marks are scaled down to 20 marks.
3. SEE is conducted for 100 Marks (3 Hours duration) as per scheme of evaluation.

**MODEL QUESTION PAPER****CIE, SKILL TEST AND SEMESTER END EXAMINATION**

<b>Course &amp; Programme:</b> Common to all Engineering Programmes.	<b>Semester:</b> II
<b>Subject:</b> Statistics and Analytics Practice	<b>Max Marks:</b> 100
<b>Course Code</b> : 20SC21P	<b>Duration</b> : 3Hrs

Instruction to the Candidate: Answer both questions

Qn.No	Question	CL	CO	PO	Marks
1	For the given ungrouped data set plot the bar graph by grouping the data in Microsoft excel spread sheet and interpret the obtained results. (Dataset, bar graphs and interpretation have to be entered in the answer script).  OR Generate a random data set in Microsoft excel spread sheet containing 50 data and find the mean mode and median in Microsoft excel spread sheet and interpret the obtained results. (Dataset, bar graphs and interpretation have to be entered in the answer script).	A	2,3	1,2,4,5,7	50
2	Write the python program to enter two integers and two strings and to print the sum two integers and two strings.	A	4	1,2,4,5,7	50

Questions are not framed from Unit 1 in the final SEE. Short questions can only be asked from that unit.

**SCHEME OF EVALUATION FOR BOTH CIE AND SEE**

Sl. No	Particulars	Marks
1	Short questions from Unit 1	10
2	Observation	30

3	Conduction	20
4	Output and Interpretation of result	20
5	Viva-voce	20
Total		100

## EQUIPMENT LIST

### FOR STATISTICS AND DATA ANALYTICS LAB

2 laboratories. Each containing 30 computers (Desktop) with the following system requirements.

SYSTEM REQUIREMENTS			
SL NO	REQUIREMENTS	MINIMUM	RECOMMENDED
1	RAM	4GB FOR FREE RAM	8GB OF TOTAL SYSTEM RAM
2	DISK SPACE	2.5 GB AND 1 GB FOR CACHES	SSD DRIVE WITH AT LEAST 5 GB OF FREE SPACE
3	MONITOR RESOLUTION	1024x768	1920×1080
4	OS(OPERATING SYSTEM)	OFFICIALLY RELEASED 64-BIT VERSIONS OF THE FOLLOWING: MICROSOFT WINDOWS 8 OR LATER	LATEST 64-BIT VERSION OF WINDOWS

**Government of Karnataka**  
**Department of Collegiate and Technical Education**  
**Board of Technical Examinations, Bangalore**

<b>Course Code</b>	20EG01P	<b>Semester</b>	I/II
<b>Course Title</b>	<b>COMMUNICATION SKILLS</b>	<b>Course Group</b>	Core
<b>No. of Credits</b>	4	<b>Type of Course</b>	Lecture + Practice
<b>Course Category</b>	Workplace Skills / Humanities & Social Sciences	<b>Total Contact Hours</b>	6Hrs Per Week
			78Hrs Per Semester
<b>Prerequisites</b>	Nil	<b>Teaching Scheme</b>	(L:T:P)= 0:1:2
<b>CIE Marks</b>	60	<b>SEE Marks</b>	40

### Preamble

Today, Communication is a very important skill for the success of every millennial student. Millennials affinity to use digital media for communication, changing career and working landscapes, and greater competition in colleges and workplaces makes enhancing student communication skills beyond language a must. Rote learning a few tips or tricks the night before an interview or performance review won't do the job if students are trying to make an impression in highly collaborative workplaces of the future. Expectations from students aspiring to be part of such future workplaces are that they have not just good verbal and non-verbal communication skills but also a good understanding of how to use modern tools for effective communication.

### Scope

To enable students to communicate clearly and effectively, by improving their verbal and non-verbal communication skills, as well as enhancing interpersonal skills and knowledge of appropriate tools for specific communication strategies.

### Course Objectives

The objectives of communication skills course are:

- Build better communication skills: oral and written expressions and body language
- Enable critical thinking
- Empower with active listening skills
- Enable team work/collaboration

### Instructional Strategy

To achieve course objectives, it is important to provide the blended mode of instruction for each of the concepts. This blended mode of instruction enables and empowers students with:

- **Understanding of Concept (Theory):**
  - Through definitions, discussions, explanation, conclusions.

- Through demonstrations: Show films or other workplace clips that model various conversation skills. This provides greater clarity of the concept by
  - Enabling observation skills
  - Helping in expression of gesture
  - building confidence
- **Application of Concept (Learning by doing):** It is imperative that to become a good communicator, the skills have to be built by applying the concept in the hypothetically created real life situations. Students are encouraged to participate in each of these activities during lab session to help build the effective communication skills.
  - Use of technology tools like audio books, apps like voice thread or paper telephone, etc.
    - To help in workplace conversions.
    - To increase active listening, pronunciation
    - To help in voice modulation
  - Group discussion
    - Reinforce active listening
    - Enable group debate to imbibe healthy communication strategies
    - Sharpen the skills of “Asking clarifying questions”
    - Sharpen Feedback / Response skills
    - Time management skills
  - Group presentations/peer reviews
    - Enable team work
    - Assess concept understanding
    - Sharpen both oral and written communication skills
  - Group activities:
    - foster critical thinking
    - enable reflective learning
  - Tools usage:
    - Understand the difference between a Dictionary and a Thesaurus
    - Understand “When” and “How” to use these tools for communication

### Course Outcomes

After completion of this course, the student shall be able to;

- Communicate
  - Identify audience (colleagues, management, customers/vendors) and use the right methodologies for communication using the right terminology, names, grades and other nomenclature pertaining to the trade, tools and specific equipment.
- Write
  - in at least one language correctly
  - basic level notes and observations
  - job cards, work sheets, basic report writing and responding to emails, simple presentations, job applications, resume
- Read
  - Technical manuals, task sheets/job orders, policies and regulations pertinent to the job, including OEM guidelines.
  - all instructions given in memos, manuals, documents or those put up as posters across the premises
  - safety precautions mentioned in equipment manuals and panels to understand the potential risks associated
- Question
  - Ask right questions

- Use different ways of asking questions
  - Clarifying/Open ended (What, Why, When, Who, Where, How)
  - Close ended
- Present
  - With right Posture & Gesture
  - With greater concept/content clarity
  - With high confidence
  - With voice modulation to capture the attention of audience
- Use technology tools
  - Office productivity
    - Word : Report writing
    - PowerPoint : Creating effective presentations
    - Excel : Data handling/Charts

**Course Content**

The following are the various units to be taught and assessed in order to ensure the student is able to demonstrate the Course Outcomes mentioned in the **Course Outcome** section.

**Pre-assessment:**

Teachers are required to administer pre-assessment before starting the actual instruction. This helps in gathering information about students’ like their attitude, beliefs, interests, and learning abilities.

**Pre assessment expectations:**

- To assess current language skill (Pronunciation, usage, sentence formation)
- To assess their ability to comprehend and respond to the instruction
- To assess their interest towards accepting ideas and learning
- To assess their current communication skills: asking questions, listening, communicating with confidence

<b>UNIT 1: English – Introduction</b>			
<b>Learning outcome:</b>			
Learn English pronunciation, functional grammar concepts& Reading. To gain confidence in spoken English.This section also covers phonemic awareness, grammar rules to set a strong base for application mode of communication.			
<b>Phonemic awareness</b>	<b>Going over 42 sounds</b>	<b>Examining the understanding of sounds</b> <b>Spelling patterns (Consonant and Vowel blending: CVC words)</b> <b>Pronunciation</b> <ul style="list-style-type: none"> <li>○ List of words given above (Commonly used words)</li> <li>○ Diction (speech)</li> </ul>	0:2:2
<b>Functional Grammar Concepts</b>	<b>Revision of Grammar concepts</b>	<b>Parts of speech</b>	2:0:0
		<b>Sentence structure</b> <i>Examples of right sentences</i>	0:1:0
		<b>Gender, Singular, Plural</b>	0:1:0

<b>Comprehension activities</b>	<b>Reading conversations (check the unit wise activity table)</b>	<i>Usage of voice (active and passive) and tenses</i>  <i>Written test for each comprehension</i>	0:2:0  0:0:2
<p><b>UNIT 2: Communication</b></p> <p><b>Lesson outcome:</b></p> <p>At the end of the session:</p> <ul style="list-style-type: none"> <li>• Students should be able to                     <ul style="list-style-type: none"> <li>○ Understand the communication process, influence of voice/tone, logical organization of thought, comprehension, listening skills.</li> <li>○ Understand the basic building blocks of communication and strategies for working with each of these blocks.</li> <li>○ Learn about carrying self, etiquettes of communication.</li> <li>○ Build positive attitude about self and towards handling communication.</li> <li>○ Learn the process for effective communication, problem solving techniques, to be confident communicator.</li> </ul> </li> </ul>			
<b>INTRODUCTI ON:</b>	<b>What is communication?</b> <b>Why communication?</b> <b>How do we communicate?</b> <b>Communication Theory and Process</b>  <b>Barriers to communication</b>	<i>How communication happens?</i> <ul style="list-style-type: none"> <li>• Pictorial representation of communication framework</li> <li>• Elements of communication: sender, receiver, message</li> <li>• Refer to activity in Unit activity section.</li> </ul> <i>Language</i> <ul style="list-style-type: none"> <li>• Lack of linguistic ability</li> <li>• Grammar</li> </ul> <i>Context</i> <ul style="list-style-type: none"> <li>• Psychology</li> <li>• Physiology</li> </ul> <i>Systematic</i> <ul style="list-style-type: none"> <li>• inefficient or inappropriate information systems</li> </ul>	1: 2:0  0:2:2  0:2:2 (video clip play, content tutorial, role play)



		<ul style="list-style-type: none"> <li>• Lack of communication channel</li> <li>• lack of understanding of the roles and responsibilities</li> </ul> <p><b>Attitude</b></p> <ul style="list-style-type: none"> <li>• Perceptions</li> <li>• Preconceived notions</li> </ul>	
<b>Building blocks of communication</b>	<b>People Message Context Listening</b>	<p><b>People:</b></p> <ul style="list-style-type: none"> <li>• Empathising with sender’s or receiver’s perception</li> <li>• Intent &amp; Impact on the sender/receiver</li> <li>• Think - Feel - Do model</li> </ul> <p><b>Message:</b></p> <p>Message channels:</p> <ul style="list-style-type: none"> <li>○ Inperson, <b>email</b>, memo, report</li> </ul> <p>Be aware of Mental Filters</p> <ul style="list-style-type: none"> <li>○ Level of understanding/knowledge</li> <li>○ Personal concerns</li> <li>○ Pre conceived notions</li> </ul> <p>Organize message:</p> <ul style="list-style-type: none"> <li>○ Critical thinking: organize your thoughts?</li> </ul> <p>Use following strategy:</p> <ul style="list-style-type: none"> <li>▪ Who</li> <li>▪ What</li> <li>▪ When</li> <li>▪ Why</li> <li>▪ How</li> </ul> <ul style="list-style-type: none"> <li>○ Bundle Primary and Secondary information</li> <li>○ Mindful about non-verbal message</li> <li>○ Tone of voice</li> </ul> <p>Examples of Types of messages:</p> <ul style="list-style-type: none"> <li>○ Inform</li> <li>○ Persuade</li> <li>○ Cyclical</li> </ul> <p>Avoiding Miscommunication:</p> <ul style="list-style-type: none"> <li>• Evaluate (Checking for) understanding of the intent of the message with the receiver – by asking clarifying questions?</li> </ul>	0:4:4

		<p><b>Context:</b>          Define context          Importance of context          Tune into context</p> <ul style="list-style-type: none"> <li>• Timing</li> <li>• Location</li> <li>• Relationship</li> </ul> <p><b>Listening:</b>          Importance of listening          Barrier to listening:</p> <ul style="list-style-type: none"> <li>• Mental filters</li> <li>• Multitasking</li> <li>• Information overload</li> </ul> <p>Strategies for listening:</p> <ul style="list-style-type: none"> <li>• Recall</li> <li>• Acknowledge</li> <li>• Summarize</li> <li>• Listen with eyes for connecting to non-verbal connection</li> <li>• Empathize</li> <li>• Pay attention</li> <li>• Ask clarifying questions</li> </ul> <p>Effective Listening Behaviors:</p> <ul style="list-style-type: none"> <li>• Maintaining relaxed body posture</li> <li>• Leaning slightly forward if sitting</li> <li>• Facing person squarely at eye level</li> <li>• Maintaining an open posture</li> <li>• Maintaining appropriate distance</li> <li>• Offering simple acknowledgements</li> <li>• Reflecting meaning (paraphrase)</li> <li>• Reflecting emotions</li> <li>• Using eye contact</li> <li>• Providing non-distracting environment</li> </ul> <p>Behaviors that hinder effective listening</p> <ul style="list-style-type: none"> <li>• Acting distracted</li> <li>• Autobiographical (Telling your own story without acknowledging theirs first)</li> <li>• No response</li> <li>• Invalidating response, put downs</li> <li>• Interrupting</li> <li>• Criticizing</li> <li>• Judging</li> <li>• Giving advice/solutions</li> <li>• Changing the subject</li> <li>• Reassuring without acknowledgment</li> </ul>	
--	--	---	--



<p><b>Using technical Jargons:</b></p>	<p><i>Assignment based project encouraging pupil to use the technical terms in the written and verbal communication.</i> This requires understanding of the core concepts (from subject teacher) and integrating the concept with communication concepts to gain the real time application knowledge.</p>	<ul style="list-style-type: none"> <li>• Criticizing</li> <li>• Judging</li> <li>• Giving advice/solutions</li> <li>• Changing the subject</li> <li>• Reassuring without acknowledgment</li> </ul>	
<p><b>UNIT4: Non-Verbal Communication:</b> <b>Lesson outcome:</b> At the end of this unit, students should be able to:</p> <ul style="list-style-type: none"> <li>• Understand the importance of Body language and its impact.</li> <li>• Use the strategies for effective body language.</li> <li>• Understand the relevance of different elements of emails and how to use them.</li> <li>• Develop the confidence in presenting written content in logical and organized manner with a definitive email framework.</li> <li>• Write different email formats confidently: Job application, Request email, apology email, email responses/feedback.</li> <li>• Confidently write Resume/Curriculum-vitae, Reports, Formal letters and portfolio.</li> <li>• Confidently communicate using technical jargons and with increased vocabulary.</li> </ul>			
<p><b>Body Language</b></p>	<p><i>Strategies</i></p>	<p>Body language tips:</p> <ul style="list-style-type: none"> <li>• Keep appropriate distance</li> <li>• Take care of your appearance</li> <li>• Maintain eye contact</li> <li>• Smile genuinely</li> </ul>	<p>0:3:4</p>

<p><b>Art of Professional writing:</b></p>	<p><b>Written communication</b></p> <p><b>Emails:</b></p> <ul style="list-style-type: none"> <li>Structured framework for writing formal emails to emphasize on professional communication in English</li> </ul>	<p>Do's and Don'ts:</p> <p>dos:</p> <ul style="list-style-type: none"> <li>smile</li> <li>stand up confident and straight</li> <li>use appropriate hand gestures</li> <li>Make eye contact with audience</li> <li>Hold neat note cards while presenting content</li> </ul> <p>Don'ts</p> <ul style="list-style-type: none"> <li>point at anyone</li> <li>rock backwards and forwards</li> <li>pace across front of room</li> <li>read off slides</li> </ul> <p>read off notes</p> <p>Different types of emails: Job application, request letter, letter writing and quick notes</p> <p>Structure of email text:</p> <ul style="list-style-type: none"> <li>Introduction – Beginning of the letter and this plays crucial role as it provides first impression to the reader. <ul style="list-style-type: none"> <li>Who: author (name + position and organisation)</li> <li>what: purpose - controlling idea (what author does or feels)</li> </ul> </li> <li>Development: Expand on the Controlling Idea/purpose of the email by answering relevant WH questions <ul style="list-style-type: none"> <li>what, when, where, who, whom, which, whose, why, and how</li> </ul> </li> <li>Conclusion: Positive words <ul style="list-style-type: none"> <li>Verb: thank, appreciate, hope, wish</li> <li>Phrases: be glad about, look forward to</li> </ul> </li> </ul> <p>Email writing samples and practice content in the activity section.</p>	<p>0:2:4</p>
--	--	---	--------------

		<p>Additional essential writing skills – Framework will be provided and assignments will be advised:</p> <ul style="list-style-type: none"> <li>• Resume writing /CurriculumVitae</li> <li>• Report Writing</li> <li>• Portfolio writing</li> <li>• Formal letters</li> </ul>	
<p><b>UNIT5: English - Reading Skills, Grammar &amp; Vocabulary</b></p> <p><b>Lesson Outcome:</b></p> <p>At the end of the session, student should be able to:</p> <ul style="list-style-type: none"> <li>• Read sentences with punctuation.</li> <li>• Understand the techniques of reading complex words.</li> <li>• Understand and apply the reading techniques for efficient reading.</li> <li>• Understand the usage of communication tools like Thesaurus and Dictionary that aids in improving vocabulary and reading.</li> <li>• Understand and apply the functional grammar aspects in day today communication.</li> </ul>			
<b>Reading skills</b>	<p><b>Comprehension activities</b></p> <p><b>Techniques for smart reading</b></p>	<p>Passage comprehension</p> <p>Conversation comprehension</p> <p>Strategies for smart reading:</p> <ul style="list-style-type: none"> <li>• Skimming and scanning through the text, inferring the meaning</li> <li>• Questioning, summarizing</li> </ul>	0:2: 2
<b>Functional Grammar</b>	<p><b>List of Commonly confused words and how to use/avoid them</b></p>	<p>Set of words to accelerate the English language learning and usage.</p> <p>Strategies to use these words effectively</p>	0:1: 2
<b>Vocabulary</b>	<p><b>Sentences:</b></p> <ul style="list-style-type: none"> <li>○ Declarative sentence</li> <li>○ Imperative sentence</li> <li>○ Interrogative sentence</li> <li>○ Exclamatory sentence</li> </ul>	<p>Techniques of categorizing sentences, understanding how to build with punctuation and effectively use in the verbal and non-verbal communication. This involves more of hands on activities.</p>	0:1: 2



<b>One-to-One</b>		Including attachment Working with “To, CC, BCC” and Subject fields effectively Using signature	
<b>One-to-Many</b>	<b><i>Presentation using PowerPoint</i></b>	Creating, Editing, Saving slides Using Animation Formatting options	0:1:2
	<b><i>Webinar / Web Presentation (zoom, Google meet, Skype)</i></b>	Hosting online meeting using online meeting tools Inviting people Sharing screen	0:1:1
<b>Other</b>	<b><i>Reports using MS Word</i></b>	Open, close, Edit and Save usage with documents Layout and strategies for creating report Sample report creation demo with follow on assignment Core subject project report submission assignment	0:1: 2
	<b><i>Data &amp; Graphs using MS Excel</i></b>	Open, close, save and edit the excel document Creating data Using basic maths operation in Excel for working with data Creating simple graphs Assignment: For example, creating statistics of subject wise activities completed for 6 months in the credit course	0:1: 2
			<b>4:34:40</b>

**Course Class Activity List (Unit-wise)**

The following are the various activities that faculty could conduct for each unit are presented below;

<b>Unit No.</b>	<b>Unit Title</b>	<b>Unit Activities</b>
<b>UNIT 1: Activities:</b>	<b>English – Introduction</b>	1. 42 sounds revision:



		<ol style="list-style-type: none"> <li>1. s, a, t, i, p, n</li> <li>2. c k, e, h, r, m, d</li> <li>3. g, o, u, l, f, b</li> <li>4. ai, j, oa, ie, ee, or</li> <li>5. z, w, ng, v, oo, oo</li> <li>6. y, x, ch, sh, th, th</li> <li>7. qu, ou, oi, ue, er, ar</li> </ol> <ul style="list-style-type: none"> <li>• This helps in reducing the native language impact</li> <li>• Helps in understanding Short and Long vowel words</li> <li>• Helps in spelling</li> <li>• Helps in pronunciation</li> </ul> <ol style="list-style-type: none"> <li>2. Reading commonly used words loud from the list (list will be provided in the workbook):             <ul style="list-style-type: none"> <li>• This helps in getting familiarity with the word pronunciation and helps in reading.</li> </ul> </li> <li>3. Blending words activity:             <ul style="list-style-type: none"> <li>• Write simple three letter words (CVC/CVCC/CVCV) pattern words: Can, Cap, Snap, cape (list will be provided in the workbook)</li> <li>• Show how to blend with the sound.</li> <li>• Starting with 3 letter words and continuing to 6 to 8 letter words. <i>Note: Remember before going through big words, it is always important to assess and ensure the student is aware of all the 42 sounds and are comfortable making small words.</i></li> </ul> </li> </ol> <p>Parts of Speech:</p> <p>building sentence using parts of speech: Demonstration by teacher: (Will be explained in the book as an example)</p> <p>Jumbled parts of speech: Student should pick the right order to build meaningful sentence:</p> <p>(More samples will be provided in the workbook)</p> <ul style="list-style-type: none"> <li>• College go to youeveryday.</li> <li>• Makes spider web the a</li> </ul> <p>Gender, Singular and Plurals:</p>
--	--	--

		<ul style="list-style-type: none"> <li>• Match the following activity for singular and plural</li> <li>• Fill in the blanks activity for genders</li> </ul> <p>Reading &amp; Comprehension: Conversation</p> <ul style="list-style-type: none"> <li>• Conversation at the bank (provided in the workbook along with few more conversation samples)</li> <li>• Questions based on this conversation will be provided in the workbook</li> </ul>
<p><b>Unit 2</b></p>	<p><b>Communication</b></p>	<p>Oral:</p> <ul style="list-style-type: none"> <li>• Introduce yourself?</li> </ul> <p>Visual:</p> <ul style="list-style-type: none"> <li>• Video clip on communication etiquette</li> <li>• Pictures (in addendum section): do's and don'ts of communication</li> </ul> <p>Group of students, one participant whispers in another participant's ear, and this message has to be passed on in a circle until it reaches back the sender. Making a note of process of message conveyed and how it was perceived.</p> <ul style="list-style-type: none"> <li>○ Identify the communication gap if any.</li> <li>○ Discuss and conclude the communication framework importance</li> <li>○ Discuss/reiterate how to make communication framework strong.</li> </ul> <p>1. Role play to assess the understanding of building blocks of communication: (can be tapered to the core skills of diploma courses, following are just few of the examples)</p> <ol style="list-style-type: none"> <li>a. Announcing the result of students in the class or</li> <li>b. Announcing the job placement of students (people, context, message, form of message)</li> <li>c. Discussing the guidelines of examination (listening skills)</li> </ol>

		<p>d. Listening to the weather forecast without seeing and making note of the listening ability (play video of weather forecast) – Assess based on how much the student is able to recall.</p> <p>2. Run National geography/Discovery Video clip/subject related technical video clip on YouTube: Check:</p> <ul style="list-style-type: none"> <li>○ if the student has not understood what a speaker expressed</li> <li>○ about work or safety related issues</li> <li>○ seeking clarification or advice appropriately from colleague, customer, management or vendor</li> </ul>
<p><b>Unit 3</b></p>	<p><b>Verbal communication</b></p>	<p>1. Voice/tone modulation: Showcase video Discussion: What was right? What was wrong? How it should have been better?</p> <p>2. Picture description activity (memory test): Class split into groups A, B C,D: (two or four groups of at least 5 people each): Teacher shows different picture to each group for three minutes. Now each group has to remember what was on the picture and discuss with each other, write down the elements on a piece of sheet and share it with the teacher. Group that remembers more will be the winner.</p> <p>Teacher to observe the body language of a student in the group, listening skills of a student, presentation skill, comprehension skill, content delivery skill, confidence level, team work. And reiterate the concepts, dos and don'ts, and discuss what could have been done better. (details of pictures will be given in the workbook)</p> <p>3. Telephonic conversation:</p>

		<p>Role play by a teacher: Call Airtel/Vodafone department and asking for the phone number portability process.</p> <p>After teacher demonstrates, teacher divides the class in to small groups of three people.</p> <ul style="list-style-type: none"> <li>• Each group will be given a different telephone conversation assignment (samples will be provided in workbook).</li> <li>• Two people in the group pretend to converse over the phone, and the third person makes a note of right and wrong approaches during the communication.</li> </ul>
<p><b>Unit 4:</b></p>	<p><b>Non-verbal communication</b></p>	<p>Body language</p> <p>Simon Says:</p> <p>Instructions and set up :</p> <ol style="list-style-type: none"> <li>1. Series of instructions to the group that are to be copied/reproduced. Start slowly and increase the pace</li> <li>2. State the following actions as YOU do them: <ul style="list-style-type: none"> <li>○ Put your hand to your nose</li> <li>○ Clap your hands</li> <li>○ Stand up</li> <li>○ Turn around</li> <li>○ Touch your shoulder</li> <li>○ Sit down</li> <li>○ Stamp your foot</li> <li>○ Cross your arms</li> <li>○ Put your hand to your forehead - <u>BUT WHILE SAYING THIS PUT YOUR HAND TO YOUR NOSE</u></li> </ul> </li> <li>3. Observe the number of group members who copy what you did rather than what you said.</li> </ol> <p><b>Outcome of this activity:</b></p> <p>Discuss how body language can reinforce/influence verbal communication and drive the importance of body language and how to work on it</p>

		<ul style="list-style-type: none"> <li>Email communication &amp; Using technical jargons:  Sample letter writing as assignment to students. (list will be provided in the text book – Request, apology, job application and relevant email formats that are useful for students post diploma course)</li> <li>There will be at least one assignment that utilizes technical jargons in email communication.</li> </ul>
<b>UNIT 5:</b>	<b>English - Reading Skills, Grammar &amp; Vocabulary</b>	<ul style="list-style-type: none"> <li>Reading passage (Provided in workbook)</li> <li>Reading passage from the text book</li> <li>Comprehension: Passage &amp; Conversation (will be provided in workbook)</li> <li>Chunking words and reading activities</li> </ul>
<b>Unit 6:</b>	<b>Communication tools</b>	<ul style="list-style-type: none"> <li>Email writing activities: Writing emails using email provider. Theme based email writing</li> <li>Report writing assignment</li> </ul> <p>Writing about a machinery tool/interior designing plan? Related to the diploma stream.</p> <ul style="list-style-type: none"> <li>Resume writing assignment</li> <li>Data handling: Collecting data about machines/number of students passed out of college for last three years and creating graph about it.</li> <li>Presentation:                         <ul style="list-style-type: none"> <li>About learning in the communication class</li> <li>Concept presentation</li> </ul> </li> </ul>

### Course Assessment Strategies

#### Assessment Methodology

- Observation (role play activities, team activities, demonstration)
- Questions & Answer – Periodic Assessment

#### Assessment Grading RUBRICS

Language Basics	
Beginner	Doesn't know / understand
Intermediate	can read and identify commonly used words
Good	Confident , able to communicate well with known people
Advanced	Confident , able to communicate well with anyone using a English

Expert	Can read, understand; Also comprehend & can train others
<b>Reading</b>	
Beginner	Beginning to read, has native language impact
Intermediate	can read, identify words, build simple 3/4/5 letter words easily
Good	Can read, understand, build words, read simple sentences ; Also comprehend
Advanced	Can read, understand, build words, read simple sentences ; Also comprehend
Expert	Confident , read simple and complex sentences with punctuation, comprehend, spell also build words
<b>Inter personal communication</b>	
Beginner	is shy, doesn't talk/express
Intermediate	hesitates to communicate – due to lack of confidence / ability, can talk to known people
Good	can talk to unknown people, less confident, does not express, has hard time working as a team
Advanced	can talk to unknown people, confident, can't express, has hard time working as a team
Expert	confident, can talk to anyone, express well, works well in the team
<b>Body language</b>	
Beginner	Is shy, not open to communicate, has hard time making friends
Intermediate	Knows basics of Body language, practices sometimes
Good	Knows basics of Body language, practices most times, has less confidence in presenting content
Advanced	Knows and practices good body language all times, can present content
Expert	Knows and practices good body language all times, is an example, Leads the pack to get better
<b>Listening Skills</b>	
Beginner	Just hears, no attention
Intermediate	Listens, pays attention, does not ask any question
Good	Listens, pays attention, ask questions
Advanced	listens, pays attention, asks questions, cannot empathize
Expert	Listens, pays attention, asks clarifying questions, able to understand the message communicated
<b>Acceptability to Learn</b>	
Low	is not receiving to information
Average	receives information but resists to implement
Good , Above Average	receives information and implements per instructions
Strong	receives information and proactively implements and seeks feedback
<b>Verbal Communication</b>	
Beginner	Does not communicate, shy, low on confidence: has problem expressing in his/her native language or English language
Intermediate	Can communicate in native language, low confidence, shy, yet to try in English language

Good	Can communicate in native language, good confidence, tries to communicate in English language
Advanced	Can communicate in native language, express view points, good confidence, comfortable talking to people in the team, tries to communicate in English language as well
Expert	Can communicate in native language, express view points, very good confidence, can communicate with anyone without any fear, asks clarifying questions, communicates well in English, or tries hard to communicate in English language as well
<b>Non-Verbal Communication</b>	
Beginner	Struggles to understand the non-verbal cues, has to work on body language, has hard time understanding the written communication aspects
Intermediate	Can understand the non-verbal cues, has to practice, tries to apply written communication aspects
Good	Can understand non-verbal cues, practices well, works hard to get hold on written communication skills, exhibits confidence in whatever task is given
Advanced	Can understand non-verbal cues, can work on written communication aspects, exhibits confidence, practices well, help others to identify non-verbal cues
Expert	Can understand non-verbal cues, train others, confident, exhibits good non-verbal cues at all times, can train the pack, has good hold on written communication as well.
<b>Comprehension</b>	
Beginner	Tries to read the passage, has hard time to comprehend
Intermediate	Can read the conversation passage, has hard time understanding the regular passage
Good	Can read the conversation passage, regular passage, but stutters in answering questions if there are technical jargons
Advanced	Can read the conversation passage, comprehend but regular passage comprehension is good
Expert	Can read the conversation passage, comprehend but regular passage comprehension is good, explain better to others, help others, lead the pack
<b>Writing Communication</b>	
Beginner	Has trouble forming right sentences for written communication
Intermediate	Can form sentences, has problem with the layout, gets confused between layout for different form of written communication
Good	Can form sentences, has fair understanding of the layout to be used for particular type of written communication, but stutters for words and expression
Advanced	Can form sentences, has good understanding of the layout to be used for particular type of written communication, confident, can express thoughts well

Expert	Can form sentences, has good understanding of the layout to be used for particular type of written communication, confident, can express thoughts well and train others and lead the pack
--------	---

### Recommended Learning Resources

<https://www.englishclub.com/grammar/parts-of-speech.htm>

Watch Amy Cuddy's TED Talk: [Your Body Language Shapes Who You Are](#)

Additional Reading: [http://money.cnn.com/2000/05/03/career/q\\_body\\_language/](http://money.cnn.com/2000/05/03/career/q_body_language/)

### Pre-assessment:

#### Activity 1:

Make a group, read random words from the list, build sentence for few words from the list.

Create a group of 3 or 5 students. Randomly pick 5 words from the word list write down on the board/show them as a chart if you have created a word chart/make chit of words and ask them to pick one chit and READ the word.

**Main idea:** Testing the pronunciation ability, language ability, confidence in speaking, ability to understand and accept the instruction

#### Activity 2:

Simple reading test – Reading passages (Simple passage from the current course book)

Show the reading passage, let each one of them read 2 lines, after first student is done with reading two lines, then the next student must pick up from there and read next two lines. This process has to be followed until the entire class is done with reading or at least ten students are done with reading.

**Main idea:** Testing listening skills, attentiveness, language ability, pronunciation ability

#### Activity 3:

Students getting to know each other. Create a group of 3 or 5 students. Each student gets chance to talk to another student, introduce him/herself to the student, ask question, make a note of the answer against the name of the student who is answering the question on a sheet of paper.



**Main idea:** To assess current communication level, body language when students talk with each other, and confidence.

**Commonly Used Word List**

When	Today	For	Off	
Give	Stop	There	Often	
Again	Little	Than	Myself	
Do	Large	At	Over	
From	Both	Like	Along	
Him	Name	Said	Why	
Can	Few	They	Has	
Go	Home	Look	Bring	
But	Big	Know	Part	
Old	Should	Done	By	
Not	Once	High	As	
Her	Thought		So	Into
Time	Better	Them	Away	
Long	Many	Does	No	
Had	Get	Always	Other	
Word	Please	These	With	
Very	Ask	Last	An	
Your	Say	Got	What	
Make	Ten	Next	Come	
Day	I	Those	Would	
Each	Show	Play	Who	
Yes	To	Girl	This	
On	Am	A	Could	
Been	Where	You	Now	
Of	Way	Be	Fun	
He	Which	Were	Only	
It	Write	Or	Much	
More	Goes	One	Tell	
My	Great	All	Out	
Any	Number		That	Fast
Their	First	Cat	Is	
We	Find	His	Small	
She	Me	Have	Dog	
Did	In	How	See	
Went	Before	Water	Here	
Full	Saw	And	People	
Some	Never	Use	School	
Then	Boy	Take	Two	
If	Right	The	Call	
Night	After	Will	Might	
Made	About	Was	May	
Up	Far	Are	Walk	

To assess current communication skill: Activity based

**Activity 3:**

Making a group of students and getting to know each other with a predefined expectation for example:

Name:

I have performed on stage:

I'm good at sports:

I can speak more than 3 languages:

I'm always cheerful:

I like my mother tongue:

**Course Assessment and Evaluation**

**Continuous Internal Evaluation (CIE)**

Sl.No	Assessment	Schedule	Duration	Max. Test marks
1	Skill Test 1	At the end of 3 <sup>rd</sup> week of the sem	2 Hrs	20
2	Skill Test 2	At the end of 7 <sup>th</sup> week of the sem	2 Hrs	20
3	Skill Test 3	At the end of 13 <sup>th</sup> week of the sem	2 Hrs	20
Total				60

**Scheme of Valuation for CIE**

Serial no	Assessment	Marks
1	<b>Portfolio Evaluation of activities / exercises conducted upto the schedule of Skill Test. (Work Book Based)</b>	<b>10</b>
2	<b>Assessment of any one through qualitative assessment ( Rubrics)</b>	<b>10</b>
<b>TOTAL</b>		<b>20</b>

**RUBRICS FOR ASSESSMENT OF ACTIVITY (10marks)  
(Qualitative Assessment)**

Dimension	Beginner	Intermediate	Good	Advanced	Expert	Student Score
	<b>2</b>	<b>4</b>	<b>6</b>	<b>8</b>	<b>10</b>	
	Descriptor	Descriptor	Descriptor	Descriptor	Descriptor	
	Descriptor	Descriptor	Descriptor	Descriptor	Descriptor	
	Descriptor	Descriptor	Descriptor	Descriptor	Descriptor	
	Descriptor	Descriptor	Descriptor	Descriptor	Descriptor	
<b>Average / Total Marks:</b>						

<b>Example Only</b>						
<b>RUBRICS FOR ASSESSMENT OF ACTIVITY (10marks)</b>						
<b>Faculty need to develop appropriate rubrics as per the assigned activity for assessment</b>						
Dimension	Beginner	Intermediate	Good	Advanced	Expert	Student Score
	2	4	6	8	10	
<b>Language Basics</b>	Doesn't know / understand	Can read and identify commonly used words	Confident , able to communicate well with known people	Confident , able to communicate well with anyone using a English	Can read, understand; Also comprehend & can train others	8
<b>Reading</b>	Beginning to read, has native language impact	Can read, identify words, build simple 3/4/5 letter words easily	Can read, understand, build words, read simple sentences ; Also comprehend	Can read, understand, build words, read simple sentences ; Also comprehend	Confident , read simple and complex sentences with punctuation, comprehend, spell also build words	6
<b>Inter personal communication</b>	Is shy, doesn't talk/express	Hesitates to communicate – due to lack of confidence / ability, can talk to known people	Can talk to unknown people, less confident, does not express, has hard time working as a team	Can talk to unknown people, confident, can't express, has hard time working as a team	Confident, can talk to anyone, express well, works well in the team	8
<b>Body language</b>	Is shy, not open to communicate, has hard time making friends	Knows basics of Body language, practices sometimes	Knows basics of Body language, practices most times, has less confidence in presenting content	Knows and practices good body language all times, can present content	Knows and practices good body language all times, is an example, Leads the pack to get better	8
<b>Average / Total Marks: (8+6+8+8)/4</b>						<b>7.5 = 8 marks</b>

**Scheme of Valuation for Semester End Examination (SEE)**

<b>Serial no</b>	<b>Assessment</b>	<b>Evidence</b>	<b>Marks</b>	<b>Conversion</b>
1	<b>Portfolio Evaluation- UNIT 1: English - Introduction</b>	<b>Work Book</b>	<b>15</b>	<b>40 Marks</b>
2	<b>Portfolio Evaluation- UNIT 2: Communication</b>	<b>Work Book</b>	<b>15</b>	
3	<b>Portfolio Evaluation- UNIT 3: Verbal Communication</b>	<b>Work Book</b>	<b>15</b>	
4	<b>Portfolio Evaluation- UNIT-4: Non-Verbal Communication:</b>	<b>Work Book</b>	<b>15</b>	
5	<b>Portfolio Evaluation- UNIT-5: English - Reading Skills, Grammar &amp; Vocabulary</b>	<b>Work Book</b>	<b>15</b>	
6	<b>Any one activity through communication tools- By qualitative assessment (Rubrics).</b>	<b>BTE Answer scripts</b>	<b>25</b>	
		<b>TOTAL</b>	<b>100</b>	

**Government of Karnataka**  
**Department of Collegiate and Technical Education**  
**Board of Technical Examinations, Bangalore**

<b>Course Code</b>	20ME02P	<b>Semester</b>	I/II
<b>Course Title</b>	<b>Computer Aided Engineering Graphics</b>	<b>Course Group</b>	CS,EC,EE & Other allied branches
<b>No. of Credits</b>	4	<b>Type of Course</b>	Lecture & Practice
<b>Course Category</b>	PC	<b>Total Contact Hours</b>	6Hrs Per Week
			78Hrs Per Semester
<b>Prerequisites</b>	Enthusiasm to learn the subject/Visualizing/Creativity	<b>Teaching Scheme</b>	(L: T:P) = 1:0:2
<b>CIE Marks</b>	60	<b>SEE Marks</b>	40

### 1. COURSE RATIONALE:

Engineering Drawing is an effective language of engineers. It is the foundation block which strengthens the engineering & technological structure. Moreover, it is the transmitting link between ideas and realization.

### 2. LIST OF COMPETENCIES:

*The course content should be taught and implemented with the aim to develop different types of skills leading to the achievement of the following competencies:*

1. Prepare engineering drawings both manually and using CAD with given geometrical dimensions using prevailing drawing standards and drafting instruments.
2. Visualize the shape of simple object from orthographic views and vice versa

### 3. COURSE OUT COMES:

<b>C01</b>	Adopt the standards, dimensioning and construct appropriate drawing scales, in technical drawing development.
<b>C02</b>	Visualize objects in all planes and learn displaying techniques for graphical communication in design process.
<b>C03</b>	Sketch orthographic projections into isometric projections and vice versa.
<b>C04</b>	Use computer software and Apply computer aided drafting tools to create 2D /3 D engineering drawings

### 4. INSTRUCTIONAL STRATEGY:

1. Teacher should show model of real of the component/part whose drawing is to be made. Emphasis should be given on cleanliness, dimensioning and layout of sheet.
2. Focus should be on proper selection of drawing instruments and their proper use.
3. The institute should procure AutoCAD or other engineering graphics software for practice in engineering drawings.
4. Separate labs for practice on Engineering graphics Software should be established.

**5 COURSE DETAILS:**

*The following topics/sub topics is to be taught and assessed in order to develop Unit Skill sets for achieving CO to attain identified skill sets*

<b>Unit</b>	<b>Major Learning Topics and Sub-Topics</b>	<b>Outcomes (in cognitive domain)</b>	<b>Hours L-T-P</b>
<b>UNIT-1</b> <b>Basic elements of Drawing</b>	1.1 List the different drawing instruments and application 1.2 Convention of lines and its application (Thick, Thin, Axis etc.) 1.3 Practice use of drawing instruments 1.4 Representative fraction Scales - Full Scale, Reduced Scale and Enlarged Scale 1.6 Dimensioning a) Aligned system and Unidirectional system in the Sketches b) Chain dimensioning and Parallel dimensioning 1.7 Construct different polygons	1. Drawing equipment's, instruments and materials. 2. Equipment's-types, specifications, method to use them, applications. 3. Instruments-types, specifications, methods to use them and applications. 4. Pencils-grades, applications, Different types of lines. 5. Scaling technique used in drawing. 6. Dimensioning methods. - Aligned method. Unilateral with chain, parallel dimensioning. 7. Constructions of geometrical figures	<b>4-0-8</b>
<b>UNIT-2</b> <b>CAD Interface</b>	22.1 Introduction to CAD- Hardware requirements. 2.2 Various CAD software available 2.3 Familiarization of CAD window - Commands like New file, Saving the file, opening an existing drawing file, Creating templates 2.4 Setting up new drawing: Units, Limits, Grid, Snap. Standard sizes of sheet. 2.5 Selecting Various plotting parameters such as Paper size, paper units, drawing orientation, plot scale, plot offset, plot area, print preview	1. CAD-Definition-Importance. 2. Familiarization with CAD Environment and utilities. 3. Setting up layout in CAD software's by taking plotting parameters	<b>4-0-8</b>
<b>UNIT-3</b> <b>Exposure to CAD Commands</b>	3.1 Draw basic entities like Line, Circle, Arc, Polygon, Ellipse, Rectangle, Multiline, Dimensioning, Inserting text Applying constraints - horizontal, vertical, parallel, concentric, perpendicular, symmetric equal, collinear 3.2 Insert title block for the drawing and take the Print out 3.3 Create objects by applying constraints and convert the objects to full scale, reduced scale and enlarged scale 3.4 Apply copy, mirroring, array, fillet and trim on the object created	1. Computer graphics & its terminology. 2. CAD definition, concept & need. 3. Commands used in CAD 4. Functional areas of CAD. - Coordinate systems. 5. Familiarization of Cad commands 6. Draw simple Geometrical figures using CAD	<b>6-0-12</b>
<b>UNIT-4</b> <b>Orthographic projections</b>	4.1 Introduction to orthographic projection 4.2 Conversion of pictorial view into Orthographic Views	1. Types of projections-orthographic concept and applications. 2. Various term associated	<b>4-0-8</b>

		with orthographic projections. (a) Theory of projection. (b) Methods of projection. (c) Orthographic projection. (d) Planes of projection. 3. Conversion of simple pictorial views into Orthographic views. Illustrative problems on orthographic projection. Note : (1) Problem should be restricted up to - Front view/Elevation, Top view/Plan and Side views only. Use First Angle Method only.	
<b>UNIT-5 Isometric projections</b>	5.1 Introduction to Isometric Projections 5.2 Isometric Scales and Actual Scale 5.3 Isometric View and Isometric Projection 5.4 Conversion of Orthographic Views into Isometric	1. Isometric axis, lines and planes. 2. Isometric scales. 3. Isometric view and isometric drawing. 4. Difference between isometric projection and isometric drawing. 5. Illustrative problems limited to Simple elements	<b>4-0-8</b>
<b>UNIT-6 CAD Drafting</b>	6.1 Draw different types of 2D/3D modeling entities using viewing commands, to view them (Problems solved in chapter no 3 and 4 i.e Orthographic, isometric projection). 6.2 2D/3D modeling for Branch specific components	1 Difference between 2D & 3D models. 2. 2D/3D modeling – concept, Simple objects	<b>4-0-8</b>
		TOTAL	<b>26-0-52</b>

**6. LIST OF PRACTICAL EXERCISES:**

The exercises/practical/experiments should be properly designed and implemented with an attempt to develop different types of skills leading to the achievement of the competency. Following is the list of exercises/practical/experiments for guidance.

Sr. No	Unit No.	Practical Exercises (Outcomes in Psychomotor Domain)	Hours
1	1	1. Teacher will demonstrate a: Use of a. Drawing instruments. b. Planning and layout as per IS. c: Scaling technique.	<b>1-0-2</b>
		2. Draw following. Problem – 1 Drawing horizontal, vertical, 30 degree, 45 degree, 60 & 75 degrees lines using Tee and Set squares/ drafter. (Sketch book)	
		Problem – 2 Indicate different convention of lines on the drawing.(SketchBook)	<b>1-0-2</b>
		Problem – 3 Copy the sketch to the required scale and dimensioning adopting right system and positioning of dimensions using Tee and Set squares / drafter. (SketchBook)	<b>1-0-2</b>



		Problem 4. Draw regular geometric constructions Pentagon, Hexagon, Square, circle, Triangle and other shapes. (SketchBook)	<b>1-0-2</b>
2	2	Use of CAD commands, plotting the drawing	<b>4-0-8</b>
3	3	Problem 5: Drawing basic entities: Circle, Arc, Polygon, Ellipse, Rectangle, Multiline	<b>6-0-12</b>
4	4	Problem 6: Draw Orthographic views for the given object. (CAD Drawing) (Minimum 5 Problems)	<b>4-0-8</b>
5	5	Problem 7: Draw Isometric projections for the given Orthographic views(CAD Drawing) (Minimum 5 Problems)	<b>4-0-8</b>
6	6	Problem 8: Produce Orthographic (2D) Drawings in CAD – Chap 3 Problem 14: Produce Isometric and 3D Drawings in CAD – Chap 4 (CAD Drawings and Printout) (Minimum 5 Problems)	<b>2-0-4</b>
		Problem 9: create 3D models of Program specific Elements such as Panel box (Minimum 3 Problems related to Program specific)) (CAD Drawings and Printout)	<b>2-0-4</b>
<b>TOTAL</b>			<b>26-0-52</b>

- 1 Theory & practice should be in first angle projections and IS codes should be followed wherever applicable.
- 2 The dimensions of line, axes, distances, angle, side of polygon, diameter, etc. must be varied for each student in batch so that each student will have same problems, but with different dimensions.
- 3 The sketchbook has to contain data of all problems, solutions of all problems and student activities performed.
- 4 Students activities are compulsory to be performed.

### 7. SUGGESTED LIST OF STUDENT ACTIVITIES:

SL.NO.	ACTIVITY
1	Sketch the combinations of set squares to draw angles in step of 15 <sup>o</sup> ,30 <sup>o</sup> , 45 <sup>o</sup> , 60 <sup>o</sup> , 75 <sup>o</sup> , 90 <sup>o</sup> , 105 <sup>o</sup> , 120 <sup>o</sup> , 135 <sup>o</sup> , 150 <sup>o</sup> , 165 <sup>o</sup> , 180 <sup>o</sup> .
2	Take two simple objects. Sketch isometric of them.
3	Take two simple objects. Sketch Pictorial orthographic views of them.
4	Prepare a 2D drawing using AutoCAD and 2D parametric sketcher environment.
5	Prepare 3D solid models using AutoCAD any one mechanical component (Four components).

### 8. SUGGESTED LEARNING RESOURCES:

1. Bureau of Indian Standards. *Engineering Drawing Practice for Schools and Colleges IS: Sp-46*. BIS. Government of India, Third Reprint, October 1998; ISBN: 81-7061-091-2.
2. Bhatt, N. D. *Engineering Drawing*. Charotar Publishing House, Anand, Gujrat 2010; ISBN: 978-93-80358-17-8.
3. Jain &Gautam, *Engineering Graphics & Design*, Khanna Publishing House, New Delhi (ISBN: 978- 93-86173-478)
4. Jolhe, D. A. *Engineering Drawing*. Tata McGraw Hill Edu. New Delhi, 2010; ISBN: 978-0-07-064837-1
5. Dhawan, R. K. *Engineering Drawing*. S. Chand and Company, New Delhi; ISBN: 81-219-1431-0.

6. Shah, P. J. *Engineering Drawing*. S. Chand and Company, New Delhi, 2008, ISBN:81-219-2964-4.
7. Kulkarni, D. M.; Rastogi, A. P.; Sarkar, A. K. *Engineering Graphics with AutoCAD* . PHI Learning Private Limited-New Delhi (2010); ISBN: 978-8120337831.
8. Jeyapooan, T. *Essentials of Engineering Drawing and Graphics using AutoCAD*. Vikas Publishing House Pvt. Ltd, Noida, 2011; ISBN: 978-8125953005.
9. Autodesk. *AutoCAD User Guide*. Autodesk Press, USA, 2015.
10. Sham, Tickoo. *AutoCAD 2016 for Engineers and Designers* .Dreamtech Press; Galgotia Publication, New Delhi, 2015; ISBN 978-9351199113.

**9. SOFTWARE/LEARNING WEBSITES :**

1. <https://www.youtube.com/watch?v=TI4jGyDWCw>
2. [https://www.youtube.com/watch?v=dmt6\\_n7Sgcg](https://www.youtube.com/watch?v=dmt6_n7Sgcg)
3. <https://www.youtube.com/watch?v= MOScnLXL0M>
4. <https://www.youtube.com/watch?v=3WXPanCq9LI>
5. <https://www.youtube.com/watch?v=fvjk7PlxAuo>
6. <http://www.me.umn.edu/coursesme2011/handouts/engg%20graphics.pdf>
7. <https://www.machinedesignonline.com>

**10. Mapping of Course Outcomes with Programme Outcomes (Suggestive only):**

Course	CO's	Programme Outcomes (PO's)						
		1	2	3	4	5	6	7
Engineering Graphics	CO1	3	0	0	3	0	0	0
	CO2	3	0	0	3	0	0	0
	CO3	3	0	0	3	0	0	0
	CO4	3	0	0	3	0	0	0
<p><b>Level 3- Highly Mapped, Level 2-Moderately Mapped, Level 1-Low Mapped, Level 0- Not Mapped</b></p> <p>Method is to relate the level of PO with the number of hours devoted to the CO s which maps the given PO.                      If <math>\geq 50\%</math> of classroom sessions related to the CO are addressing a particular PO, it is considered that PO is mapped at Level 3                      If 30 to 50% of classroom sessions related to the CO are addressing a particular PO, it is considered that PO is mapped at Level 2                      If 5 to 30% of classroom sessions related to the CO are addressing a particular PO, it is considered that PO is mapped at Level 1                      If <math>&lt; 5\%</math> of classroom sessions related to the CO are addressing a particular PO, it is considered that PO is considered not mapped i.e. Level 0</p>								

**11. COURSE ASSESSMENT AND EVALUATION CHART:**

Sl. No	Assessment	Time frame in semester	Duration	Max marks	Conversion
1.	Portfolio Evaluation of Drawings (CAD Practice Exercises)	Entire Duration	-	20	<b>20</b>
2	Skill Test-1 (Skill test 1-Unit 1&2)	At the end of 4 week	3 Hrs	100	Average of two skill tests 1and 2 (Both skill tests are to be reduced to weightage of 20 independently) 20
3	Skill Test-2 (Skill test 2 is of CAD based-Unit,3,4)	At the end of 8 week	3 Hrs	100	

4	Skill Test-3 (Skill test 3 is of CAD based Unit 5,6)	At the end of 13 week	3 Hrs	100	Skill tests-3 is to be reduced to weightage of 20
5	Total Continuous Internal Evaluation (CIE) Assessment				<b>60</b>
6	Semester End Examination (SEE) Assessment conducted for 100 marks, finally reduced to 40 marks weightage		3 Hrs	100	<b>40</b>
				<b>TOTAL</b>	<b>100</b>

**Scheme of Valuation for End Examination**

SL NO	QUESTIONS	MARKS
1.	Create Orthographic views for the given Pictorial drawing. Indicate all Dimensions and Annotations. (CAD)	<b>50</b>
<b>OR</b>		
	Create Isometric Projections for the given Orthographic views (CAD)	<b>50</b>
2.	Create 3D drawing for the given Sketch (CAD)	<b>50</b>
		<b>TOTAL</b>
		<b>100</b>

**12. CAD Laboratory and Other Requirements to Conduct Engineering Graphics Course**

1. Latest Configuration Computers which can be able to run latest any Computer Aided Drafting Software. (At least One Computer per student in practical session.)-30 no
2. Any latest Authorized Computer Aided Drafting Software (30 user licenses)
3. Plotter of size A2/A3
4. LCD Projector.

**MODEL QUESTION BANK (Suggestive only)**

1. Draw six horizontal parallel lines of 50 mm long with 10 mm intervals (Fig 1).



2. Draw six vertical parallel lines of 50 mm length with 10 mm intervals (Fig 2)

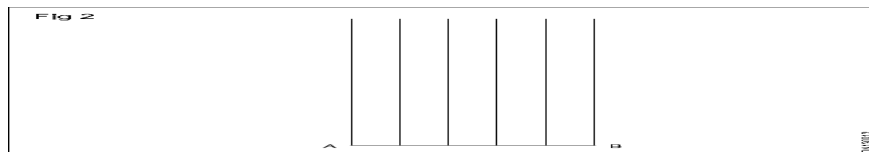

3. Draw 45° inclined lines (Fig 3).

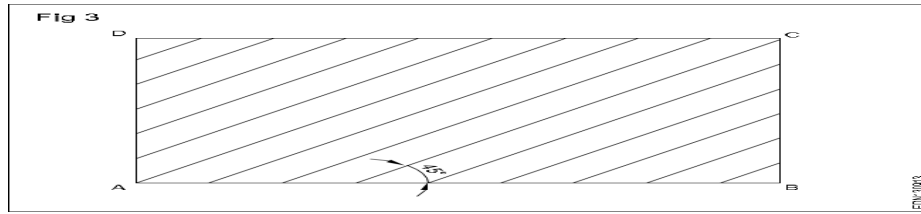

4. Draw the given types of lines using 0.5 range thickness of line according to the specification (Fig 4).

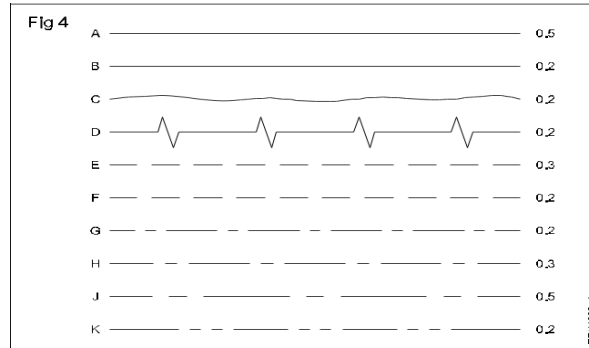

5. Draw the following Exercises in A4 sheet (Fig 5).

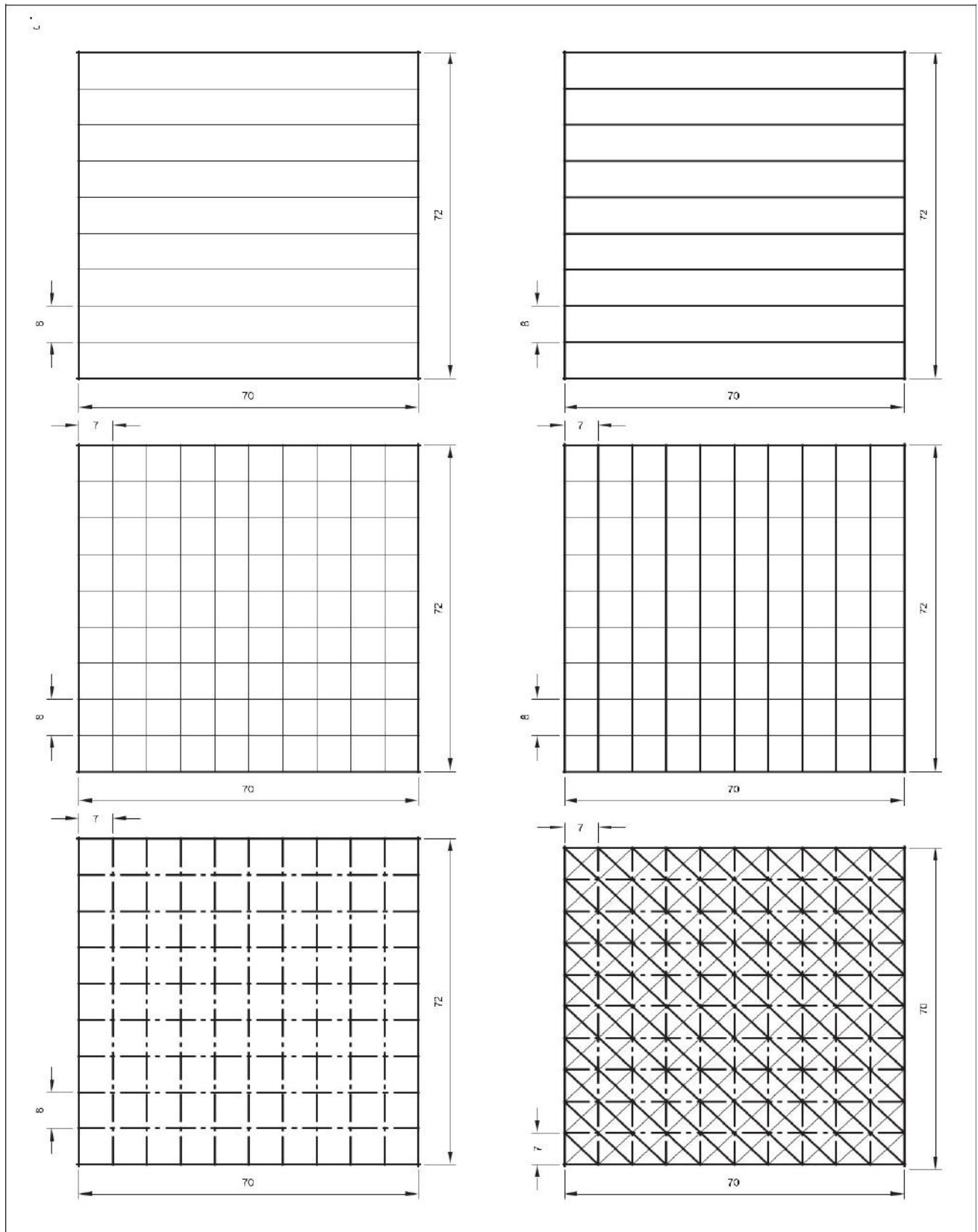

6a ) Illustrate the elements of dimensioning with the help of a sketch.

b) Illustrate the dimensioning of given common features: diameter, radius, chord, Arc and angle.

7. Copy the sketch to 1:1 scale and dimension it using Aligned system.

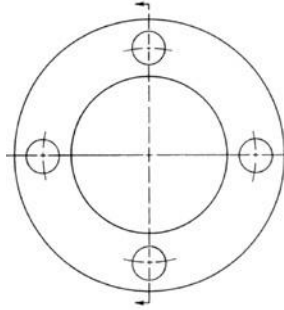

8. Copy the sketch to 1:1 scale and dimension it using unidirectional system with Parallel dimensioning method.

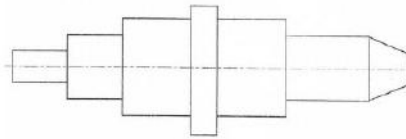

9. Copy the sketch to 1:1 scale and dimension it using Aligned system with Chain dimensioning method.

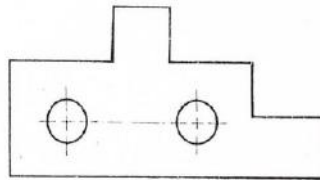

10. Copy the sketch to 1:1 scale and dimension it using Aligned system with Parallel dimensioning method.

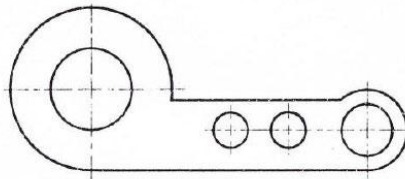

11. Copy the sketch to 1:1 scale and dimension it using unidirectional system with Chain dimensioning method

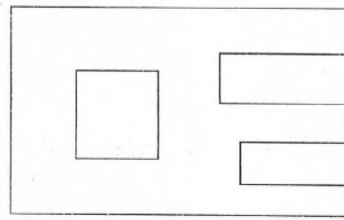

12. Copy the sketch to 1:1 scale and dimension it using unidirectional system with Parallel dimensioning method.

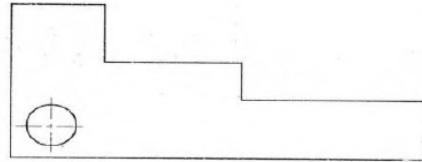

### ORTHOGRAPHIC REJECTIONS

1. Draw the three principal views of the component as shown in the figure.

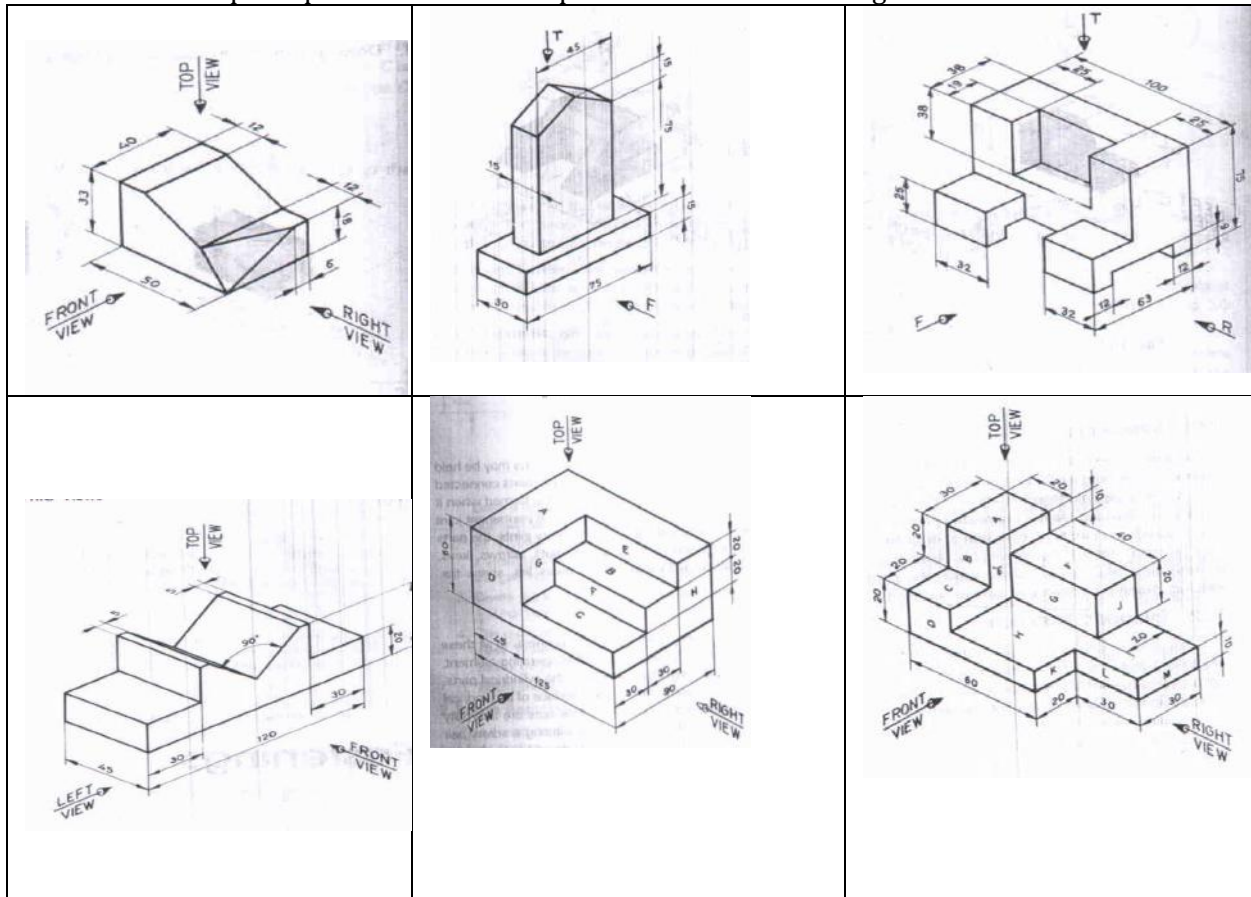

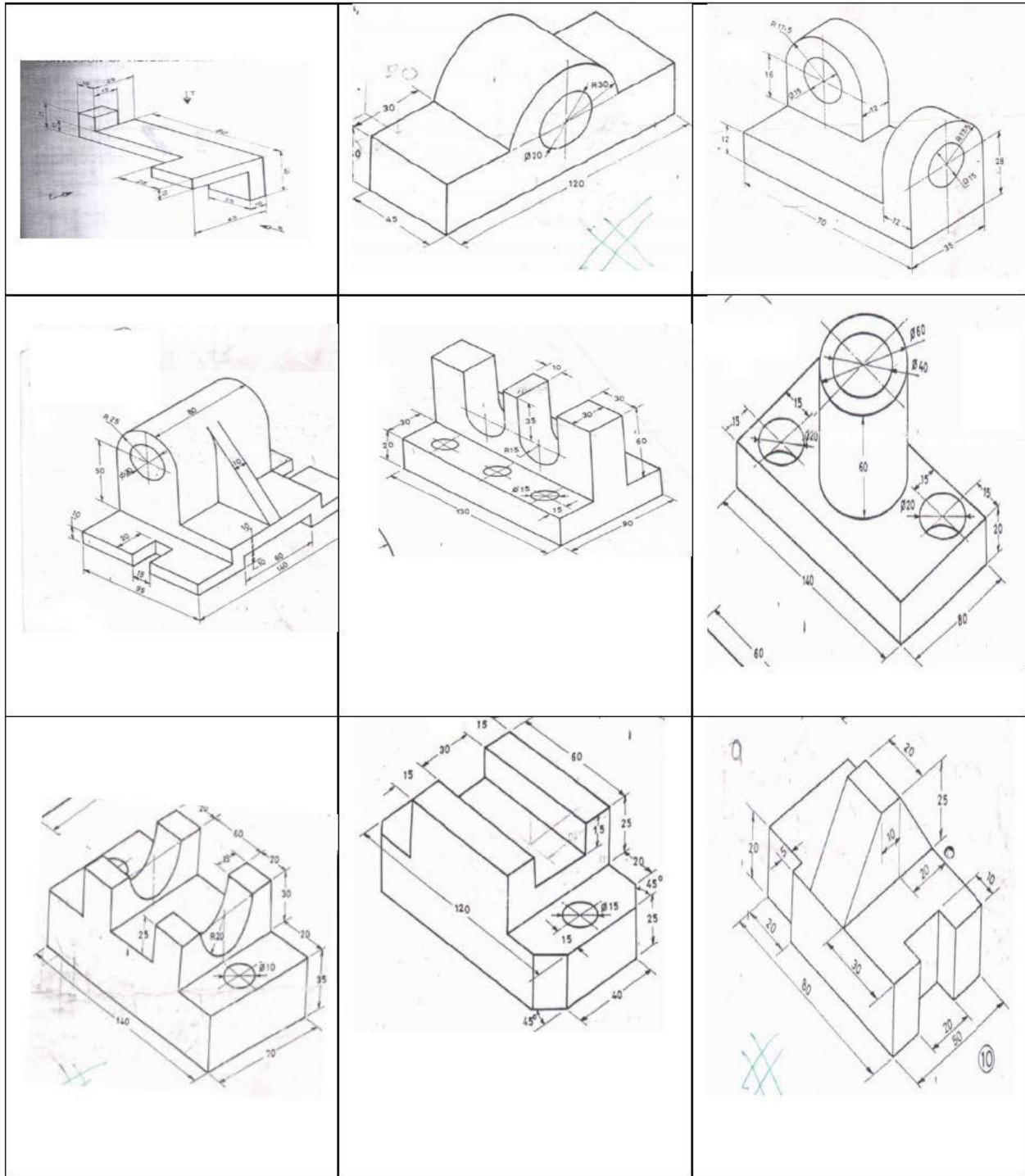



### ISOMETRIC PROJECTIONS

1. Draw the isometric view of the machine component whose orthographic views are given below:

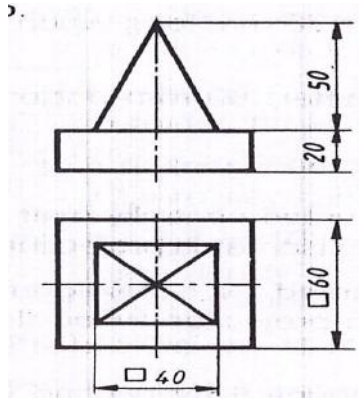
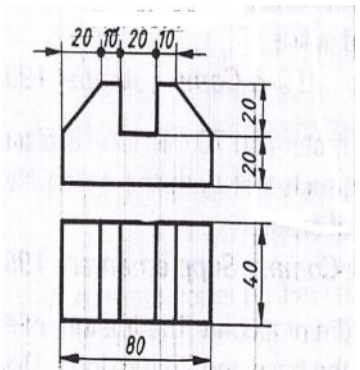
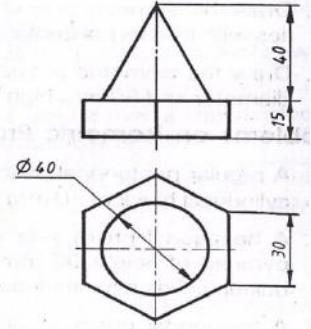
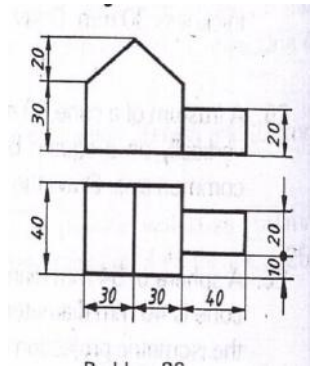
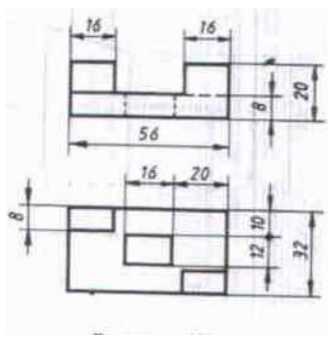
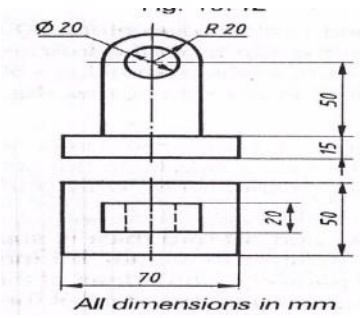
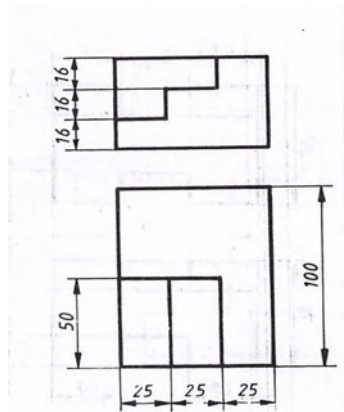
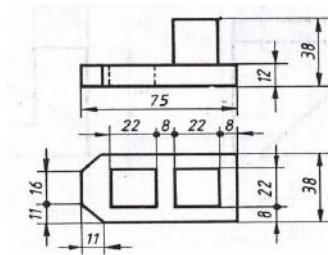
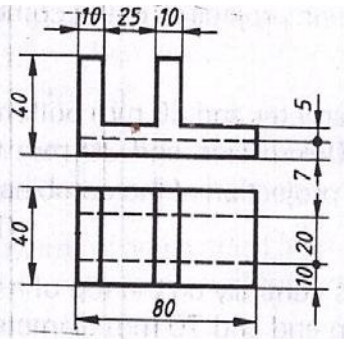
<p>1.</p> 	<p>2.</p> 	<p>3.</p> 
<p>4.</p> 	<p>5.</p> 	<p>6.</p>  <p>All dimensions in mm</p>
<p>7.</p> 	<p>8.</p> 	<p>9.</p>  <p>All dimensions in mm</p>

2. Draw the isometric Projection of the machine component whose orthographic views are given below:

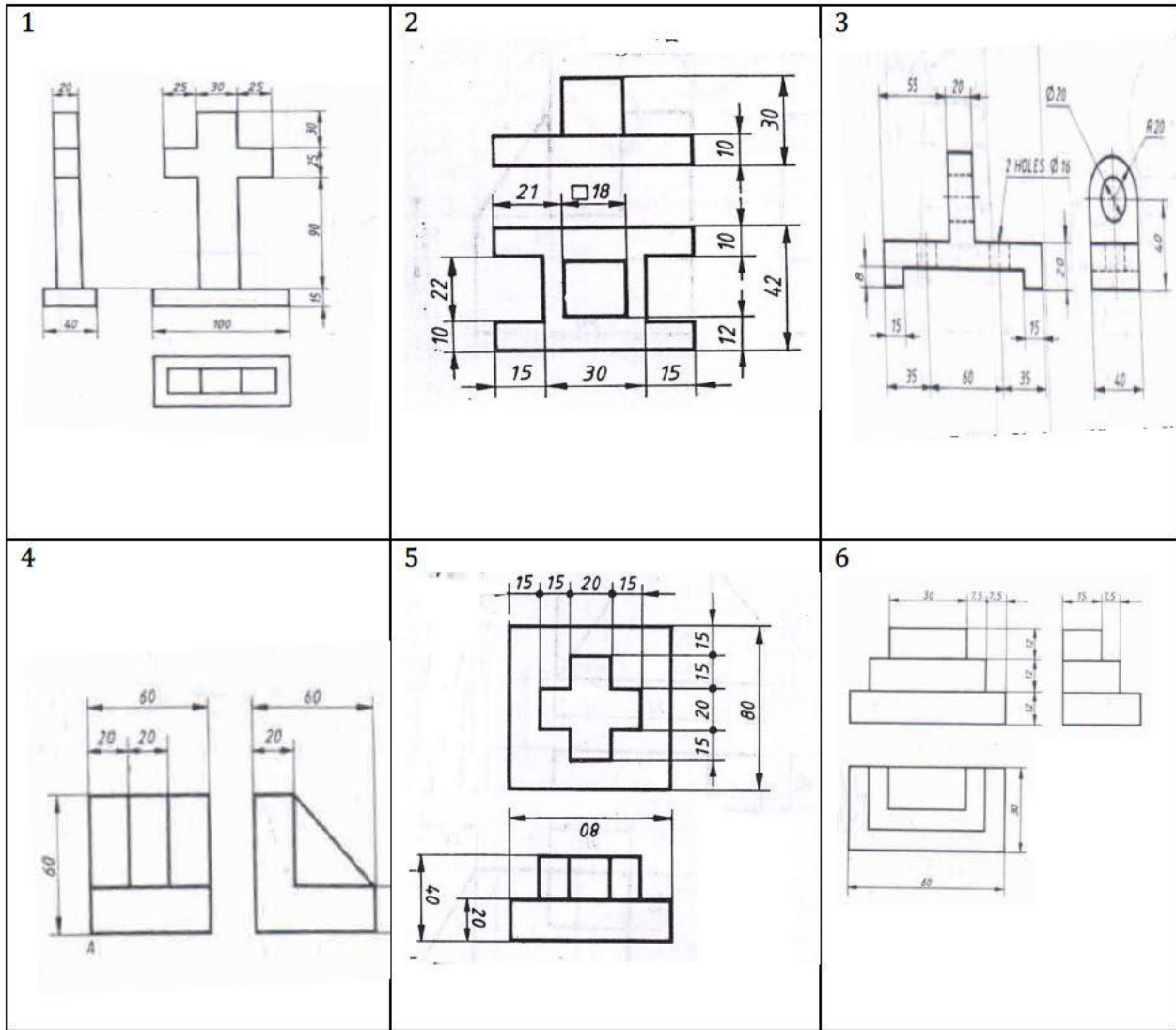

3. Draw the isometric Projection of the machine component whose orthographic views are given below

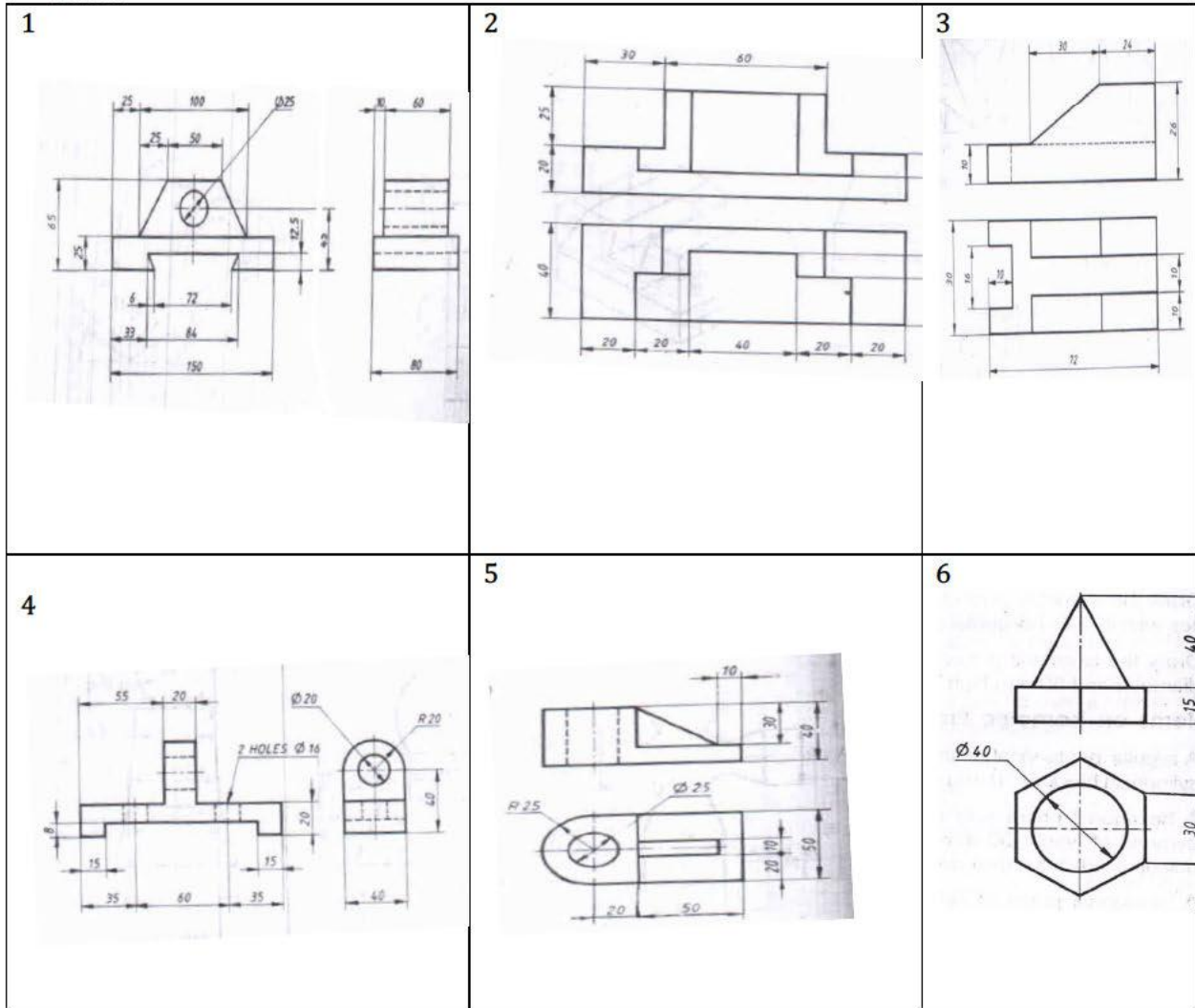

4. Draw the isometric View of the machine component whose orthographic views are given below

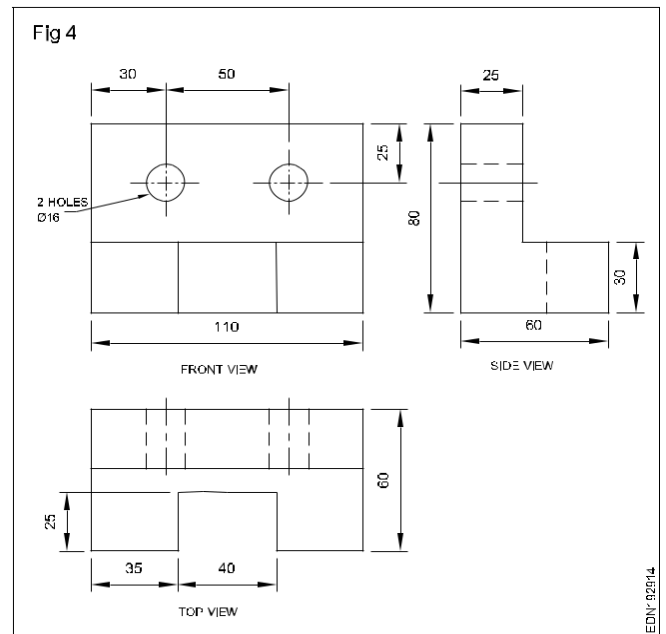
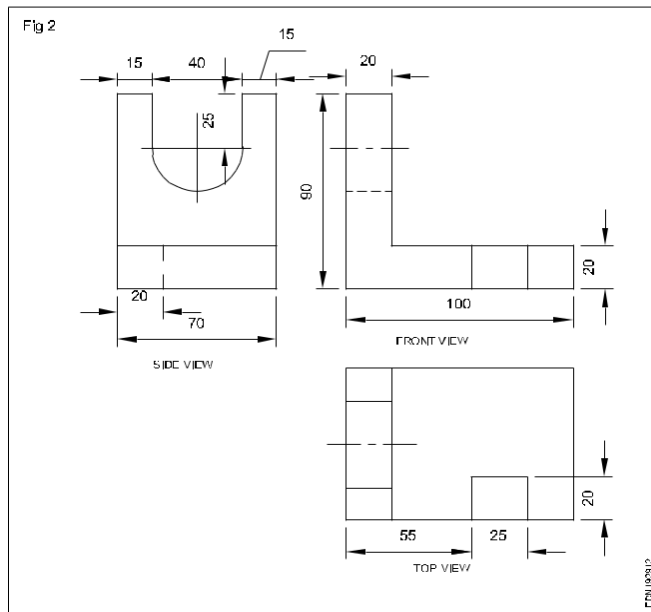
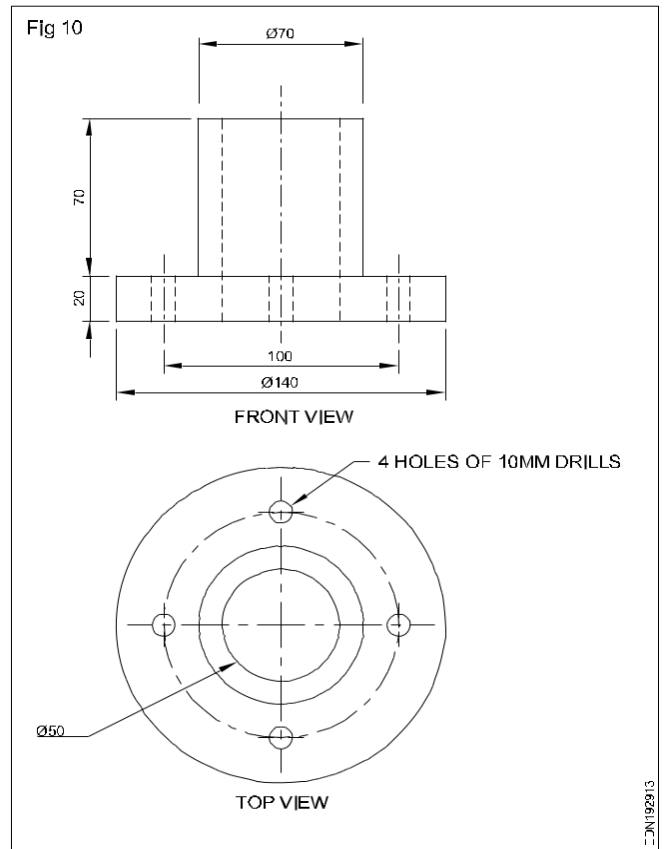
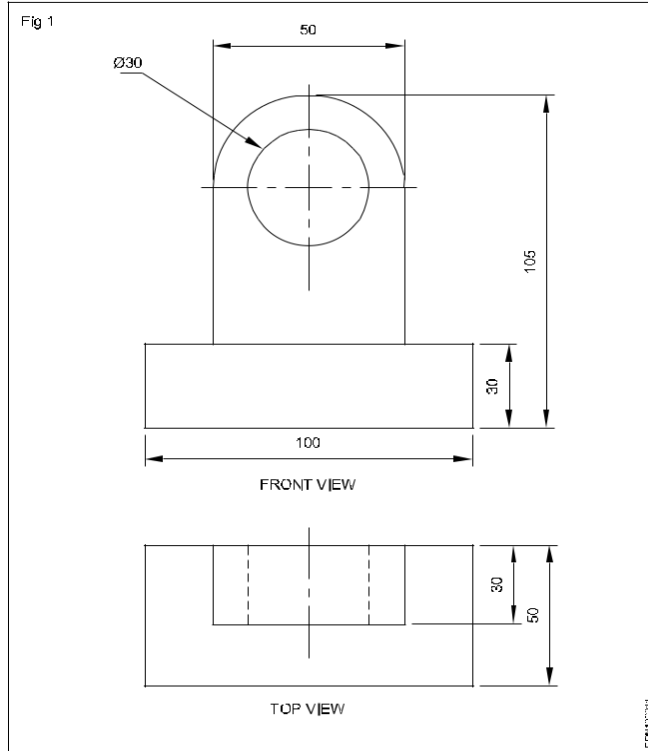

## Government of Karnataka

## Department of Collegiate and Technical Education

## Board of Technical Examinations, Bangalore

<b>Course Code</b>	20CS21P	<b>Semester</b>	II
<b>Course Title</b>	MULTIMEDIA & ANIMATION	<b>Course Group</b>	Core
<b>No. of Credits</b>	4	<b>Type of Course</b>	Lecture + Practice
<b>Course Category</b>	PC	<b>Total Contact Hours</b>	6Hrs Per Week
			78Hrs Per Semester
<b>Prerequisites</b>	Nil	<b>Teaching Scheme</b>	(L: T:P) = 1:0:2
<b>CIE Marks</b>	60	<b>SEE Marks</b>	40

**1. RATIONALE**

Multimedia is one of the very effective forms of communication through which students can enhance their presentation skills. Learning multimedia enables the brain's ability to make connections between verbal and visual representations of content, leading to a deeper understanding, which in turn supports the transfer of learning to other situations. Animation is the broad field of study that allows one to show their creativity, amplify their imagination and exercise graphic and technical skills.

**2. COURSE SKILL SET**

The aim of the course is to help the student to attain the following industry identified competency through various teaching learning experiences

**Perform jobs related to Multimedia – Text, Image, Audio, Video, and Animation.**

**3. COURSE OBJECTIVES**

6. Explore Multimedia features and applications
7. Demonstrate various Photo editing techniques to enhance visual effects of the image
8. Construct graphic design.
9. Demonstrate animation principles.

**4. JOB ROLE**

SL.NO	LEVEL	JOB ROLES
1	3	Freelance Photo Editor and Graphic Designer
2	3	Junior Creative Designer/Digital Artist
3	3	Junior Animator

**5. PREREQUISITES**

STUDENT	Nil.
TEACHER	FDP training on Multimedia and Animation course.

**6. COURSE OUTCOMES**

On successful completion of the course, the students will be able to demonstrate industry-oriented COs associated with the above-mentioned competency:

COURSE OUTCOME		CL	LINKED PO	TEACHING HOURS
CO1	Identify basic Multimedia features and applications.	U	1,4	06
CO2	Compile various Photo Editing techniques to create excellent Images.	U,A	1,4,7	27
CO3	Construct graphic design / web design like Advertisement/logo/flyer/Invitation Card/Banner/web site.	U,A	1,4,7	09
CO4	Animate geometrical objects by applying different animation principles.	U,A	1,4,7	36

**Legends:** R = Remember; U = Understand; A = Apply and above levels (Bloom's revised taxonomy)

**7. SUGGESTED SPECIFICATION TABLE WITH HOURS & MARKS(THEORY)**

UNITNO.	UNIT NAME	TEACHING HOURS	DISTRIBUTION OF THEORY MARKS			
			R	U	A	TOTAL
1	Introduction to Multimedia Systems	6				
2	Image editing	24				
3	Graphic Design	12				
4	Animation	36				
	<b>Total</b>	<b>78</b>				<b>200</b>

**8. INSTRUCTIONAL STRATEGY**

**These are sample strategies, which teacher can use to accelerate the attainment of the various course outcomes**

1. Instructors should expose students to explore User Interface thoroughly.
2. Demonstration using visual/graphic content should be delivered. Emphasis should be given on presentational skills.
3. Arrange visits to nearby Photo studios/ Advertising Industries/ DTP centres/other related industries.
4. Students should be exposed to other relevant & similar software and their interfaces.

**9. DETAILS OF COURSE CONTENT**

The following topics/subtopics is to be taught and assessed in order to develop Unit Skill sets for achieving CO to attain identified skill sets

UNIT NO	TOPICS/SUBTOPICS	LEARNING OUTCOME (IN COGNITIVE DOMAIN)	HOURS L : P
1	<b>INTRODUCTION TO MULTIMEDIA SYSTEMS</b>		6

	<p>1.1 Introduction</p> <ul style="list-style-type: none"> <li>▪ Significant Features</li> <li>▪ Classifications</li> <li>▪ Applications</li> </ul> <p>1.2 Multimedia Building blocks</p> <ul style="list-style-type: none"> <li>▪ Text</li> <li>▪ Audio</li> <li>▪ Image</li> <li>▪ Animation</li> <li>▪ Video</li> <li>▪ Image Data Types</li> </ul> <p>1.3 Multimedia Image and Graphics</p> <ul style="list-style-type: none"> <li>▪ Resolution, Size and Compression</li> <li>▪ File formats</li> </ul> <p>1.4 Multimedia Hardware</p> <ul style="list-style-type: none"> <li>▪ Interfaces</li> <li>▪ I/O Devices</li> <li>▪ Storage</li> <li>▪ Communication Devices.</li> </ul>	<p>1. Identity Multimedia features and Applications</p> <p>2. Describe building blocks of multimedia</p> <p>3. Classify multimedia data types and file formats</p> <p>4. Discuss multimedia hardware</p>	<p>2:4</p>
<b>2</b>	<b>IMAGE EDITING</b>		<b>24</b>
	<p>2.1 Explore image editing tool interface.</p> <ul style="list-style-type: none"> <li>▪ Customizing Workspaces.</li> <li>▪ File Handling</li> <li>▪ Setting size and resolution parameters.</li> <li>▪ Importing files.</li> <li>▪ Navigating open document</li> </ul> <p>2.2 Working with Layers</p> <p>2.3 Exploring Selection Tools</p>	<p>1. Explore interfaces of editing tool</p> <p>2. Perform photo compositing</p> <p>3. Create abstract art</p> <p>4. Apply image editing techniques</p>	<p>1:2</p> <p>11:22</p>



	<p>2.4 Exploring Layer Styles</p> <p>2.5 Using filters</p> <p>2.6 Image editing techniques</p> <ul style="list-style-type: none"> <li>▪ Adjusting exposure(brightness)</li> <li>▪ Adjusting color</li> <li>▪ Cropping and adjusting aspect ratio</li> <li>▪ Dodging and burning</li> <li>▪ Retouching</li> <li>▪ Sharpening and noise reduction</li> </ul>		
<b>3</b>	<b>GRAPHIC DESIGN</b>		<b>12</b>
	<p>3.1 Design a graphic</p> <ul style="list-style-type: none"> <li>▪ Cards</li> <li>▪ Flyer</li> <li>▪ Banner</li> <li>▪ Advertisement</li> </ul> <p>3.2 Using blend modes create</p> <ul style="list-style-type: none"> <li>▪ Logo</li> <li>▪ Poster</li> </ul> <p>3.3 Creating custom shape &amp; text wrapping</p>	<ol style="list-style-type: none"> <li>1. Construct a graphic design for a theme</li> <li>2. Create social media graphic (like emoji's)</li> </ol>	
<b>4</b>	<b>ANIMATION</b>		<b>36</b>
	<p>4.1 Exploring User Interface</p> <ul style="list-style-type: none"> <li>▪ Installation &amp; Configuration</li> <li>▪ Getting to know about Editors, Scenes and Objects</li> </ul> <p>4.2 Fundamentals of Animation.</p>	<ol style="list-style-type: none"> <li>1. Explore interfaces of Animation Tool.</li> <li>2. Applying foundation principles of animation</li> </ol>	3:6



	iv) Scale the image up and down.				
4	Design a Greeting card. Use different Layers for image and text.	2	1,4,7	2	1:2
5	Practice using different Selection tools.	2	1,4,7	2	1:2
6	Practice using different painting tools.	2	1,4	2	1:2
7	Restore old monochrome photos to a new one. Apply suitable colors.	2	1,4,7	2	1:2
8	Import a similar picture from the internet. Erase unwanted parts in the image, retouch old photos into new. Color partially.	2	1,4,7	2	1:2
9	Import a picture of a stationary motorcyclist. Apply suitable masking filters and background. The image should appear as though the motorcyclist is speeding fast.	2	1,4,7	2	1:2
10	Create a professional web layout. Use different layers, textures, colors, text, blending features and filter masking.	2	1,4,7	2	1:2
11	Create an innovative logo for your Institute considering all the features of your Institute.	2	1,4,7	3	1:2
12	Design a flyer for a short term course that is supposed to commence from 3 weeks ahead from the current date.	2	1,4,7	3	1:2
13	i) Add different objects to the space. Practice with both shortcut keys and menus.  ii) Perform Transformation operations on objects added in 14 (i)	3	1,4,7	4	1:2
14	Create primitive objects like an ice cream cone, snowman, house, tunnel and like.	3	1,4,7	4	2:4
15	Change the structure of objects by editing Vertices, Edges, Faces and transform the same and observe the changes.	3	1,4,7	4	1:2
16	Design a red ball lying on green grass. Apply suitable texture and render the same.	3	1,4,7	4	2:4

17	Animate the ball in Ex. 15 (both rigid and elastic) to bounce thrice and roll. Use suitable animation principles. Add a booning sound when the ball bounces.	3	1,4,7	4	2:4
18	Design two playing dice and animate the same. Add suitable sound for dice fall.	3	1,4,7	4	2:4
19	Show the animation of water flowing out from a pipe around a suitable environment.	3	1,4,7	4	2:4
<b>Total Hours</b>				<b>26 0:52 =78</b>	

The **suggested practical exercises** specified above are demonstrated for the attainment of the competency. These practical activities can also be used for the student assessment in portfolio mode for awarding CIE marks. **The lecturer can enhance the competency level of the students by sketching more practical exercises.**

**NOTES:**

8. It is compulsory to prepare log book/record of exercises. It is also required to get each exercise recorded in logbook, checked and duly dated signed by the teacher
9. Student activities are compulsory and are also required to be performed and noted in logbook.
10. Student activity is compulsory and part of skill assessment. The activity enables student to explore the course, help student to demonstrate creativity & critical thinking.
11. Student activity report is compulsory part to be submitted at the time of practical ESE
12. Term work report is compulsory part to be submitted at the time of practical ESE.
13. Student activity and student activity reports must be uploaded to Learning management system.
14. For CIE, students are to be assessed for Skills/competencies achieved.

**11. MAPPING OF CO WITH PO**

COURSE	CO'S	PROGRAMME OUTCOMES (PO'S)						
		1	2	3	4	5	6	7
<b>MULTIMEDIA &amp; ANIMATION</b>	CO1	3	-	-	3	-	-	2
	CO2	3	-	-	3	-	-	3

	C03	3	-	-	3	-	-	3
	C04	3			3			3
Level 3- Highly Mapped, Level 2-Moderately Mapped, Level 1-Low Mapped, Level 0- Not Mapped								

## 12. SUGGESTED LEARNING RESOURCES

BOOKS	
1	The Illusion of Life / Frank Thomas and Ollie Johnston
2	The Animator's Survival Kit / Richard Williams
3	Animation For Beginners / Morr Meroz
URL'S	
1	<a href="https://webneel.com/">https://webneel.com/</a>
2	<a href="https://clippingpathindia.com/">https://clippingpathindia.com/</a>
3	<a href="https://www.photoshopessentials.com/basics/">https://www.photoshopessentials.com/basics/</a> <a href="https://www.befunky.com/">https://www.befunky.com/</a>
4	<a href="https://www.creativebloq.com/advice/understand-the-12-principles-of-animation">https://www.creativebloq.com/advice/understand-the-12-principles-of-animation</a>
5	<a href="https://www.cgtarian.com/animation-tutorials/disney-animation-principles.html">https://www.cgtarian.com/animation-tutorials/disney-animation-principles.html</a>
6	<a href="https://ohmy.disney.com/movies/2016/07/20/twelve-principles-animation-disney/">https://ohmy.disney.com/movies/2016/07/20/twelve-principles-animation-disney/</a>
7	<a href="https://wave.video/blog/12-basic-principles-of-animation/">https://wave.video/blog/12-basic-principles-of-animation/</a>
8	<a href="https://www.youtube.com/watch?v=ILqOWe3zAbk&amp;list=PLa1F2ddGya-UvuAqHAksYnB0qL9yWDO6&amp;index=2">https://www.youtube.com/watch?v=ILqOWe3zAbk&amp;list=PLa1F2ddGya - UvuAqHAksYnB0qL9yWDO6&amp;index=2</a>

9	<a href="https://www.youtube.com/watch?v=8XyIYRW_2xk&amp;list=PLa1F2ddGya-UvuAqHAksYnB0qL9yWDO6&amp;index=3">https://www.youtube.com/watch?v=8XyIYRW_2xk&amp;list=PLa1F2ddGya - UvuAqHAksYnB0qL9yWDO6&amp;index=3</a>
10	<a href="https://www.youtube.com/watch?v=hTL6AKR8YDs&amp;list=PLa1F2ddGya-UvuAqHAksYnB0qL9yWDO6&amp;index=4">https://www.youtube.com/watch?v=hTL6AKR8YDs&amp;list=PLa1F2ddGya - UvuAqHAksYnB0qL9yWDO6&amp;index=4</a>
11	<a href="https://www.youtube.com/watch?v=JSAobQPRLwc&amp;list=PLa1F2ddGya-UvuAqHAksYnB0qL9yWDO6&amp;index=5">https://www.youtube.com/watch?v=JSAobQPRLwc&amp;list=PLa1F2ddGya - UvuAqHAksYnB0qL9yWDO6&amp;index=5</a>
12	<a href="https://www.youtube.com/watch?v=7DNmaR7TKwU&amp;list=PLa1F2ddGya-UvuAqHAksYnB0qL9yWDO6&amp;index=7">https://www.youtube.com/watch?v=7DNmaR7TKwU&amp;list=PLa1F2ddGya - UvuAqHAksYnB0qL9yWDO6&amp;index=7</a>

### 13. SUGGESTED LIST OF PROPOSED STUDENT ACTIVITYS

Note: the following activities or similar activities for assessing CIE (IA)

SL. NO	ACTIVITY
1	Create a Collage of college events with various layouts
2	Create a flyer or advertisement for social issue.
3	Create a matte painting of a mountain region
4	Create scenery with a mirror reflection and proper lighting effect.
6	Create colourful balls and apply animation effects such that balls fall from a table and roll in different directions.
7	Animate blossoming of a flower.
8	Leaf falling from a tree.

**14. COURSE ASSESSMENT AND EVALUATION CHART**

SL.NO	ASSESSMENT	DURATION (in minutes)	MAX MARKS	CONVERSION
1	CIE Assessment 1 ( Written Test -1 TH) - At the end of 3 <sup>d</sup> week	60	20	Average of two written tests 20
2	CIE Assessment 2 (Written Test -2 TH) - At the end of 13 <sup>th</sup> week	60	20	
3	CIE Assessment 3 (Skill Test) - At the end of 5 <sup>th</sup> week	3 hrs	20	Average of three skill test 20
4	CIE Assessment 4 (Skill Test) - At the end of 7 <sup>th</sup> week	3 hrs	20	
5	CIE Assessment 5 (Skill Test) - At the end of 9 <sup>th</sup> week	3 hrs	20	
6	CIE Assessment 6 (Student activity)- At the end of 11 <sup>th</sup> week	-	20	20
7	<b>Total Continuous Internal Evaluation (CIE) Assessment</b>			<b>60</b>
8	Semester End Examination(SEE) Assessment (Practical Test)	3 hrs	100	40
<b>TOAL MARKS</b>				<b>100</b>
Note: CIE written test is conducted for 100 marks (Two sections). Each section shall have two full questions of same CL, CO. Student shall answer one full question from each section.				

**15. RUBRICS FOR EVALUATION OF ACTIVITY**

<b>RUBRICS FOR ACTIVITY</b>						
<b>Dimension</b>	<b>Poor</b>	<b>Below Average</b>	<b>Average</b>	<b>Good</b>	<b>Exemplary</b>	<b>Student Score</b>
	<b>2</b>	<b>4</b>	<b>6</b>	<b>8</b>	<b>10</b>	
<b>Project Guidelines Compliance</b>	Guidelines have not been followed.	Guidelines have been followed with little noise.	Guidelines have been followed to an average extent.	Guidelines have been followed and executed to maximum extent.	All guidelines have been exceptionally followed and executed.	8
<b>Concept/ Idea</b>	No thought given to the subject. No idea or concept presented in the work.	Cliché idea or concept. Needs to brainstorm and apply fresh ideas.	Average idea or concept. Subject is presented in a typical manner	Good idea or concept. Subject is presented in a competent manner.	Good use of an idea or concept. Presented the idea in a unique and novel way.	6
<b>Editing Techniques</b>	Lacks demonstration of qualities and characteristics of various techniques and processes.	Demonstrates few qualities and characteristics of various techniques and processes, but unreliable.	Demonstrates some qualities and characteristics of various techniques and processes.	Good demonstration of qualities and characteristics of various techniques and processes	Excellent demonstration of qualities and characteristics of all techniques and processes expected.	8
<b>Graphic Design</b>	Limited or no expression of creative ideas and thoughts.	Designing needs more planning and creativity.	Competent development of creative ideas.	Excellent approach to creative thinking and expression.	Refined and sophisticated approach to original and unique presentation.	8



<b>Animation &amp; Rendering</b>	3D animation / rendering is not done at all. Lacks knowledge on saving and appropriately naming files.	3D animation / rendering is incomplete. Expected to improve in techniques. Saved in appropriately named file	3D animation / rendering is completed. Works/looks satisfactorily and saved in an appropriately named file.	3D animation / rendering is done well, works/looks properly and saved in an appropriately named file.	3D animation / rendering is done extremely well, works/looks properly and is saved in an appropriately named file.	7
<b>Appeal</b>	Messy and confusing.	Presentation can be better.	Good.	Excellent show.	Exemplary. Very well organized.	7
<b>Average / Total Marks: (8+6+8+8+7+7)/6</b>						<b>7.3 = 8 marks</b>

**16. RUBRICS FOR SKILL TEST EVALUATION (CIE & SEE)**

Sl. No.	Parameter to be observed	Marks Allotted
1	Selection of suitable tool	10
2	Comfort level of working on UI	
3	Techniques Applied	30
4	Completion of task	40
5	Appeal	20
<b>Total</b>		<b>100</b>

Note: Execution of task Image Editing & Graphic Design / Animation.

**17.SYSTEM REQUIREMENTS:**

Sl. No.	Specification	Quantity
1.	Computers with HD Graphics Card	20
2.	Software: GIMP, KRETA, BLENDER, PHOTOSHOP or any other relevant open-source software.	-
3.	Internet Connectivity,	-

**Note: Above specification is for a batch of 20 students**

**ದ್ವಿತೀಯ ಸೆಮಿಸ್ಟರ್ ಕನ್ನಡ ಬಾರದ / ಕನ್ನಡೇತರ ಡಿಪ್ಲೋಮಾ ವಿದ್ಯಾರ್ಥಿಗಳಿಗೆ  
ನಿಗದಿಪಡಿಸಿದ ಪಠ್ಯಕ್ರಮ  
ಬಳಕೆ ಕನ್ನಡ - 1**

Course Code	20KA21T	Semester : II	Course Group – AU/KA
Course Title	<b>ಬಳಕೆ ಕನ್ನಡ – I</b>	Category : AU	Lecture Course
No. of Credits	2	Type of Course	CIE Marks : 50
Total Contact Hours	2 Hrs Per Week 26Hrs Per Semester	Teaching Scheme (L:T:P)= 2:0:0	SEE Marks : Nil

**Table of Contents (ಪರಿವಿಡಿ)**

<b>Part – 1</b>	<b>Teaching Hour</b>
Introduction to the Book, Necessity of learning a local language, Tips to learn the language with easy methods. Easy learning of a Kannada Language: A few tips. Hints for correct and polite conservation. Instructions to Teachers for Listening and Speaking Activities.	<b>02</b>
<b>Part – II</b>	
Key to Transcription for Correct Pronunciation of Kannada Language, Instructions to Teachers to teach Kannada Language	<b>02</b>
<b>Part – III Lessons to teach Kannada Language - Listening and Speaking Activities</b>	
<b>Lesson – 1</b> Personal Pronouns, Possessive Forms, Interrogative words	<b>02</b>
<b>Lesson – 2</b> Possessive forms of nouns, dubitive question and Relative nouns	<b>02</b>
<b>Lesson – 3</b> Qualitative, Quantitative and Colour Adjectives, Numerals	<b>02</b>
<b>Lesson – 4</b> Predictive Forms, Locative Case	<b>02</b>
<b>Lesson – 5</b> Dative Cases, and Numerals	<b>02</b>
<b>Lesson – 6</b> Ordinal numerals and Plural markers	<b>02</b>
<b>Lesson – 7</b> Defective / Negative Verbs and Colour Adjectives	<b>02</b>
<b>Lesson – 8</b> Permission, Commands, encouraging and Urging words (Imperative words and sentences)	<b>02</b>
<b>Lesson – 9</b> Accusative Cases and Potential Forms used in General Communication	<b>02</b>
<b>Lesson – 10</b> Helping Verbs “iru and iralla”, Corresponding Future and Negation Verbs	<b>02</b>
<b>Lesson – 11</b> Do's and Don'ts in Learning of Kannada Language (Any Language in General)	<b>01</b>
<b>Lesson – 12</b> Kannada Vocabulary List : ಸಂಭಾಷಣೆಯಲ್ಲಿ ದಿನೋಪಯೋಗಿ ಕನ್ನಡ ಪದಗಳು -	<b>01</b>
Kannada Words in Conversation	<b>Total Teaching</b>
<b>Hours</b>	<b>26 Hours</b>

**ದ್ವಿತೀಯ ಸೆಮಿಸ್ಟರ್ ಕನ್ನಡ ಬಲ್ಲ ಡಿಪ್ಲೋಮಾ ವಿದ್ಯಾರ್ಥಿಗಳಿಗೆ  
ನಿಗದಿಪಡಿಸಿದ ಪಠ್ಯಕ್ರಮ  
(ಕನ್ನಡ ಭಾಷೆ, ಸಾಹಿತ್ಯ, ಸಂಸ್ಕೃತಿ ಮತ್ತು ಪರಂಪರೆ ಕುರಿತು)**

Course Code	20KA21T	Semester : II	Course Group – AU/KA
Course Title	ಸಾಹಿತ್ಯ ಸಿಂಚನ - ೧	Category : AU	Lecture Course
No. of Credits	2	Type of Course	CIE Marks : 50
Total Contact Hours	2 Hrs per Week 26 Hrs per Semester	Teaching Scheme (L:T:P)= 2:0:0	SEE Marks : Nil

**ಸಾಹಿತ್ಯ ಸಿಂಚನ - ೧ (ಕಾರ್ಯಪುಸ್ತಕ) (20KA21T)**

ಪಠ್ಯಪುಸ್ತಕದ ಪರಿವಿಡಿ	ಬೋಧನಾ ಅವಧಿ
1. ಕರ್ನಾಟಕದ ಸಂಕ್ಷಿಪ್ತ ಇತಿಹಾಸ ಮತ್ತು ಸಾಹಿತ್ಯದ ಬೆಳವಣಿಗೆ	01 ಗಂಟೆ
2. ಕನ್ನಡ ಸಾಹಿತ್ಯದ ಸಂಕ್ಷಿಪ್ತ ಚರಿತ್ರೆ	01 ಗಂಟೆ
3. ಹಳಗನ್ನಡ ಸಾಹಿತ್ಯ - ಪಂಪ ಪೂರ್ವ ಯುಗ ಕನ್ನಡ ಸಾಹಿತ್ಯದ ರಚನೆಗೆ ಪ್ರಮುಖ ಪ್ರೇರಣೆಗಳು ಮತ್ತು ಪ್ರಭಾವಗಳು ಕನ್ನಡ ಸಾಹಿತ್ಯ ಪರಂಪರೆ ಮತ್ತು ರಾಜಾಶ್ರಯ ಕವಿರಾಜಮಾರ್ಗ ಮತ್ತು ವಡ್ಡಾರಾಧನೆ	03 ಗಂಟೆ
4. ಪಂಪ / ಚಂಪೂ ಯುಗದ ಕನ್ನಡ ಸಾಹಿತ್ಯ ಮತ್ತು ಪರಂಪರೆ ಆದಿಕವಿ ಪಂಪ, ರನ್ನ, ಪೊನ್ನ, ಜನ್ನ. ಒಂದನೇ ನಾಗವರ್ಮ ಮತ್ತು ನಾಗಚಂದ್ರ 10 ಮತ್ತು 11ನೇ ಶತಮಾನದ ಸಮಕಾಲೀನ ಪ್ರಮುಖ ಕವಿಗಳು	04 ಗಂಟೆ
5. ನಡುಗನ್ನಡ ಸಾಹಿತ್ಯ - ವಚನ ಸಾಹಿತ್ಯ / ಬಸವ ಯುಗ ವಚನ ಸಾಹಿತ್ಯದ ಬೆಳವಣಿಗೆಗೆ ಕಾರಣಗಳು ಮತ್ತು ಅದರ ಮಹತ್ವ ಪ್ರಮುಖ ವಚನಕಾರರು, ವಚನ ಸಾಹಿತ್ಯದಲ್ಲಿ ವೈಚಾರಿಕತೆ ಮತ್ತು ಕಾಯಕ ತತ್ವ	04 ಗಂಟೆ
6. ಕುಮಾರವ್ಯಾಸ ಯುಗ ಮತ್ತು ಸಾಹಿತ್ಯದ ಇತರೆ ರೂಪಗಳು ರಗಳೆ - ಹರಿಹರ, ಷಟ್ಪದಿ - ಕುಮಾರವ್ಯಾಸ, ಲಕ್ಷ್ಮೀಶ ಮತ್ತು ರಾಘವಾಂಕ ಸಾಂಗತ್ಯ - ರತ್ನಾಕರವರ್ಣಿ,	04 ಗಂಟೆ
7. ದಾಸ ಸಾಹಿತ್ಯ / ಕೀರ್ತನೆಗಳು ಪುರಂದರದಾಸರು, ಕನಕದಾಸರು ಮತ್ತು ಇತರೆ ಕೀರ್ತನೆಕಾರರು	02 ಗಂಟೆ
8. ಇತರೆ ಸಾಹಿತ್ಯದ ಪ್ರಕಾರಗಳು ತ್ರಿಪದಿ - ಸರ್ವಜ್ಞ, ಜಾನಪದ ಸಾಹಿತ್ಯ, ತತ್ವಪದಗಳು - ಶಿಶುನಾಳ ಶರೀಫರು	04 ಗಂಟೆ
9. ಮಹಿಳಾ ಸಾಹಿತ್ಯ : ಹೆಳವನಕಟ್ಟೆ ಗಿರಿಯಮ್ಮ ಮತ್ತು ಸಂಚಿಹೊನ್ನಮ್ಮ, ಆಧುನಿಕ ಪೂರ್ವ ಕನ್ನಡ ಸಾಹಿತ್ಯ : ಕೆಂಪುನಾರಾಯಣ ಮತ್ತು ಮುದ್ದಣ	02 ಗಂಟೆ
10. ಹಳಗನ್ನಡ ಮತ್ತು ನಡುಗನ್ನಡ ಸಾಹಿತ್ಯ ಚರಿತ್ರೆಯ ಒಂದು ಅವಲೋಕನ	01 ಗಂಟೆ
<b>ಒಟ್ಟು ಬೋಧನಾ ಅವಧಿ 26 ಗಂಟೆಗಳು</b>	<b>26 ಗಂಟೆ</b>

ಬಳಕೆ ಕನ್ನಡ -I ಮತ್ತು ಸಾಹಿತ್ಯ ಸಿಂಚನ -೦೧ ಪಠ್ಯಕ್ರಮಗಳಿಗೆ ನಿರಂತರ ಆಂತರಿಕ ಮೌಲ್ಯಮಾಪನದ

ಮಾರ್ಗಸೂಚಿಗಳು

(COURSE ASSESSMENTS AND EVALUATION CHART- CIE ONLY)

Sl.No	Assessment	Type	Time frame in semester	Duration	Max marks	Conversion
1.	CIE Assessment 1	Written test-1	- At the end of 3 <sup>d</sup> week	80 minutes	30	Average of three written tests-1,2,3 for 30 marks
2	CIE Assessment 2	Written test-2	- At the end of 7 week	80 minutes	30	
3	CIE Assessment 3	Written test-3	- At the end of 13 week	80 minutes	30	
4	CIE Assessment 4	MCQ/Quiz	- At the end of 5 week	60 minutes	20	Average of three Assessment 4,5,6 for 20 marks
5	CIE Assessment 5	Open book test	- At the end of 9 week	60 minutes	20	
6	CIE Assessment 6	Student activity & presentation	- At the end of 11 week	60 minutes	20	
Total Continuous Internal Evaluation (CIE) Assessment						<b>50</b>
					<b>Total Marks</b>	<b>50</b>